

VDOT GOVERNANCE DOCUMENT

3D Model Development Manual

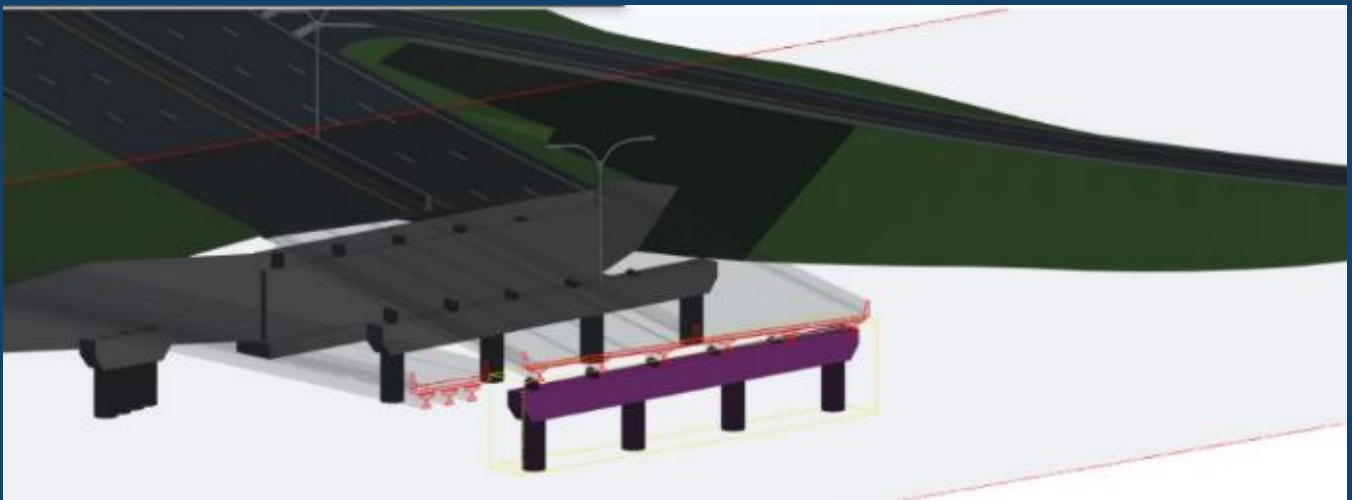

Location and Design Division
Issued October, 2020

CONTENTS

1.0 3D MODELS IN THE PROJECT DEVELOPMENT PROCESS 1-2

 1.1 Applicability 1-2

 1.2 Level of Detail to Develop Model 1-3

 1.3 Level of Effort to Develop Model 1-4

 1.3.1 Model Development Best Practices 1-5

 1.3.2 Frequently Asked Questions 1-6

2.0 MODEL DEVELOPMENT THROUGH PROJECT DEVELOPMENT MILESTONES 2-8

 2.1 Scoping Phase 2-8

 2.1.1 Establish the Scope of the 3D Model 2-8

 2.2 Preliminary Design Phase 2-9

 2.2.1 Establish 3D Model Uses for Public Engagement 2-9

 2.2.2 LOD for Public Hearing Milestone 2-10

 2.3 Detailed Design Phase 2-11

 2.3.1 LOD for Field Inspection Milestone 2-11

 2.4 Final Design and R/W Acquisition Phase 2-11

 2.4.1 LOD for Right-of-Way Milestone 2-12

TABLES

Table 1 –Summary of Level of Detail Types 1-3

Table 2 – Summary of Modeled Elements by Category 1-4

APPENDICES

Appendix A – Level of Detail Tables for Specific Milestones

ACKNOWLEDGEMENTS

VDOT thanks the Georgia DOT for their willingness to allow us to utilize large portions of their “*3D Modeling Best Practices & FAQ*” document as it served as a basis for several sections of this Manual.

ACRONYMS

AMG	Automated Machine Guidance
BIM	Building Information Modeling
CADD	Computer Aided Design and Drafting
CIM	Civil Integrated Management
DTM	Digital Terrain Model
FHWA	Federal Highway Administration
FI	Field Inspection
ITS	Intelligent Transportation Systems
LOD	Level of Detail
LOE	Level of Effort
ORD	OpenRoads Designer
MOT	Maintenance of Traffic
PDP	Project Development Process
PH	Public Hearing
R/W	Right-of-Way
VDOT	Virginia Department of Transportation
VR	Virtual Reality
XML	Extensible Markup Language

1.0 3D MODELS IN THE PROJECT DEVELOPMENT PROCESS

The Virginia Department of Transportation (VDOT) continues to expand its use of 3D data throughout all life cycle phases for the assets it owns. 3D design models can be used to distribute multiple successful formats that communicate the designer's intent. As other DOTs across the country are realizing, there are tangible benefits to every type of roadway project using 3D models. These benefits are present in both the project development and delivery phases. Project development benefits include improved plan quality; increased efficiency in plan development, decreased design error, and improved public engagement. Project delivery benefits include increased collaboration using mobile platforms, automated machine guidance (AMG), and utilization of V/R.

VDOT has developed the 3D Model Development Guidance Manual (the Manual) to specifically address the requirements of the 3D model during the PDP with the understanding there will be direct benefit during project delivery phase. Future versions of the Manual are expected to include additional detail on QA and constructability review efforts. In the interim, this Manual has discussions on best practices, frequently asked questions, and expectations of the model at different milestones. These sections can give an indication of what efforts may be needed during model review.

According to the Federal Highway Administration (FHWA), "*...The term civil integrated management (CIM) has been adopted in recent years to encompass an assortment of practices and tools entailing collection, organization, and management of information in digital formats about highway or other transportation construction projects.*" The fundamentals of engineering design has not dramatically changed, but the utilization of CIM (similar to Building Information Modeling or BIM in the vertical industry) brings a greater need for consistent model outputs, both from a geometric and information point of view. Tasks such as, 4D scheduling and construction sequencing, cannot be successfully achieved without this consistency.

3D modeling will come with the typical challenges of implementing new initiatives into the design process. VDOT recognizes that developing an accurate 3D model will require a reallocation of design time. A unique challenge of implementing the 3D modeling initiative, and likely the most difficult to overcome, will be the required change in the designer's mindset from designing cross sections to designing a continuous surface. To address this aspect, the manual includes a discussion on the level of detail (LOD) that is required and the associated level of effort (LOE) that is anticipated for 3D model development at each project development milestone.

1.1 Applicability



This manual is applicable to any project that is following the requirements of IIM-LD-118.

1.2 Level of Detail to Develop Model

This document addresses the LOD by defining the evolving maturity of the 3D model throughout the project development process (PDP). For purposes of designing proposed conditions, the LOD is broken into three types (100, 200, and 300 level) each depict two features: the level of information and the level of graphical detail. In simple terms, these levels define the graphical and non-graphical detail. The graphical detail will show the actual size and geometry of the object, for example a steel beam will be presented as its sectional size and length, whereas the non-graphical information will include the fire rating, steel grade and anti-corrosion protection etc.

The following table summarizes the LOD types (100, 200, and 300) as they relate project design detail. There are other levels, such as 400, which is the level of fabrication or as-built conditions.

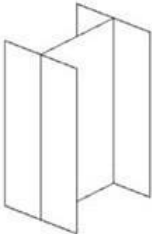
Table 1 –Summary of Level of Detail Types

LOD Type	Basis of Design	Content Requirements	Uses	Example Graphic
100	Conceptual Geometry	Overall concept indicative of height, volume, location, and orientation. Graphic depicts the existence of a component but not indicative of its shape, size, or precise location. Concept to be three-dimensional and may include other data.	Limited analysis, aggregate preliminary cost estimating, conceptual level scheduling and staging.	
200	Detailed Geometry	Elements are modeled as generalized assemblies or systems with approximate quantities, size, shape, location, and orientation. 3D elements may be associated to the activity or task in the approved baseline schedule and schedule updates.	Preliminary analysis, accurate for cost estimating and scheduling.	
300	Final Geometry	Elements are modeled as specific assemblies and are accurate in quantity, size, shape, locations, and orientation. 3D elements are associated to the activity or task in the approved baseline schedule and schedule updates.	Construction documents, detailed quantity take offs, analysis and project management and controls.	

The following table summarize the elements by category (e.g., structure or roadway) that are to be included in the 3D model. Not every element will be modeled to a 300 level. For example, elements in the drainage category (e.g., drainage pipes) may only be modeled to a 200 level. Appendix A includes spreadsheets that summarizes the level to which each element is to be modeled as well expected. The LODs identified in Appendix A should be generally treated as minimum levels. There may be cases where a higher LOD is warranted based on specific aspects of the project. Any deviations to the LOD of specific elements should be agreed upon at project scoping as discussed in Section 2.1 of this manual.

Table 2 – Summary of Modeled Elements by Category

Structures		Roadway	Drainage
<ul style="list-style-type: none"> Parapets Decks Girders Concrete Pedestal Railings Pier Caps Bearings / Pedestals Pier Columns Pier Footings Crashwalls Piles Shafts Abutments 	<ul style="list-style-type: none"> Slope Paving Wing Walls Truss / Frame Footing Piles Soundwalls Retaining Walls Concrete Barriers Gantry Sheetpiles Approaches Proposed railings Existing substructures 	<ul style="list-style-type: none"> Pavements Roadway Ramps Entrance gutters Sidewalks Shared Use Paths Entrances Guardrail Attenuators Curb and Gutter Islands Raised Medians Grading 	<ul style="list-style-type: none"> Drainage Structures Drainage pipes Underdrain Basins
Lighting & Electrical	Landscaping	Utilities	ITS
<ul style="list-style-type: none"> Lighting Poles Luminaires Junction Boxes Conduits Cabinets Electrical Service All Foundations 	<ul style="list-style-type: none"> Erosion & Sediment Control Fences 	<ul style="list-style-type: none"> Proposed utility structures Proposed utility pipe Proposed fire standpipe systems 	<ul style="list-style-type: none"> Manholes Boxes Exterior Generators Cabinets Conduit DMS Signs Land Use Signals Poles & Mounted Equipment Gates
Traffic Signals	Tunnel	Building	Temporary Works
<ul style="list-style-type: none"> Signal Poles Cabinets Pedestrian Poles Mast Arms, Span Wires, Flashing Beacons Junction Boxes Conduits Electrical Service Loop Detectors All Foundations 	<ul style="list-style-type: none"> Tunnel Profile Tunnel Slab Tunnel Traffic Barrier Tunnel Egress Corridor Wall & Opening Tunnel Egress Corridor Wall Door Approach Structure Slurry Wall Capping Beam Fire Extinguisher Cabinet Air Quality Sensor 	<ul style="list-style-type: none"> Tunnel Profile Tunnel Slab Tunnel Traffic Barrier Tunnel Egress Corridor Wall & Opening Tunnel Egress Corridor Wall Door Approach Structure Slurry Wall Capping Beam Fire Extinguisher Cabinet Air Quality Sensor 	<ul style="list-style-type: none"> Work Zones Barges Cranes/ Pile Driver/ Equipment Temporary Trestle Cofferdams Temporary Bridges Temporary Pavement for MOT Material staging/stockpiles Construction Entrance
Pavement Marking & Signing			
<ul style="list-style-type: none"> Signage Permanent Pavement Marking All sign foundations 			

1.3 Level of Effort to Develop Model

The investment in developing a 3D model results in overall cost savings through the project development process (PDP) by providing greater flexibility and functionality to the project team. It also requires the designer reappportion their time to dedicate more time on the model elements. As such this manual includes a discussion on modeling best practices, frequently asked questions from other

DOTs, and a brief discussion of modeling effort for each subsequent milestone within the respective milestone section of this manual.

1.3.1 Model Development Best Practices

The following are geometric design software best practices. Several of these practices have been developed by other DOT across the country including Georgia and Utah. These should be viewed as methods or techniques that lend themselves to efficient model development. They are not intended to be directives as to how the model must be developed or managed. However, VDOT strongly encourages the use of best practices to create a consistent workflow and product until a repeatable process has been developed through the Central Office CADD Program area.

- Utilize secondary alignments (horizontal/vertical) and point controls (in cross sections) to define edges of pavement, shoulder break points, medians/islands, or other elements varying in offset from the centerline
- Utilize parametric constraints
- Each road alignment to be modeled is considered a "corridor" and should be categorized independently.
- Limit the number of cross section templates to a practical minimum
 - As a rough rule of thumb, the designer should strive to create one template for each typical section shown in the plans and utilize display rules and/or end condition exceptions when necessary to vary tie-ins
 - The designer is encouraged to think of a template as a typical section, and to think of an end condition exception as a typical section detail (guardrail or wall location, etc.)
- Utilize a logical and consistent naming convention for cross section elements, components, and points. Inconsistencies in point names at different cross sections can cause problems with the 3D model
- Do not use single station template drops
- Do not code in truly vertical surfaces in cross elements or 3D models
- Always give vertical surfaces (e.g. walls) a very slight slope to avoid problems with the 3D model
 - This can be checked by toggling the "triangulated surface" in the roadway designer view
- Walls should be modeled in the sense that there should be a "vertical" drop (avoid truly vertical elements in model by assigning an insignificant slope) in the proposed surface. Modeling the wall in 3D may illuminate to designers the need to extend or modify the wall based on a 3D evaluation, rather than only checking it at even cross section stations.
- The 3D model should be used in conjunction with the traditional workflows to increase productivity and identify design issues more quickly. For example:
 - In horizontal design, store alignments for inside and outside edge of pavements/shoulder break points and define the "seam" line between the mainline and side street at intersections
 - In vertical design, ensure sidestreet profiles match the mainline cross slope and consider skew, turn lanes, etc.

- In cross section design, consider the template drop frequency, add Key Stations where needed, and give no priority/special attention to even cross sections - all stations are equally important
- In preliminary design, model the bridge endrolls
- Consideration to move towards an alternative form of grading diagram as reliance on cross section during project delivery lessens. The current approach utilizes cross sections to meet grading diagram requirements. The grading diagrams require knowing the existing root mat, existing pavement and what will be constructed in a particular phase. Some designers will model the existing pavement, while root mat is considered by the cross section, due to height of fill considerations.
- For the reviewer, the focus should be to ensure the 3D model looks reasonable and that there are no major concerns, especially in areas traditionally not shown in the plans. View the proposed DTM surfaces electronically in 3D, rotate the surface in many different views and visually inspect for problem areas. The nature of the problem area will determine if the model needs to be altered during preliminary design, final design, or not at all. For example, if a side street surface ties nicely into the mainline as expected, but the radius returns need adjusting, an alteration of the model could likely wait until final design since no significant footprint changes would be expected. On the other hand, if a review of the 3D model reveals that the design is not properly accounting for a turn lane taper or a guardrail anchor pad, addressing these concerns during preliminary design would be appropriate since they are more likely to affect the project footprint.
- When reviewing the model, Rotate the proposed surface in 3D to review
 - Setting the Display Style (in “view attributes” dialog box) to wireframe, smooth, smooth with shadows, or illustration can help visibility when reviewing the 3D model.

1.3.2 Frequently Asked Questions

The following are frequent asked questions as developed by the Georgia DOT. These are intended to serve as supplemental information to the requirements of this manual. In the event of any inconsistency or conflict between these FAQs and the requirements of this manual, the requirements shall supersede.

Do I need to provide merged surfaces?

Yes. The “finish” Land XML file should include one surface comprised of the mainline, sidestreets, and any other surfaces (e.g. driveways, bridge endrolls) merged together. The “finish” surface, however, should not be merged with the existing ground surface which is provided as a separate file.

Does my model have to be “perfect”?

No. The designer should keep in mind that 3D models will be incomplete and imperfect by their nature but, in general, are sufficient for construction. The designer’s goal should be to produce a practical and accurate 3D model, not a perfect 3D model. Not every triangulation issue needs to be resolved and not every transition needs to be smooth. Contractors and surveyors are often able to work out smaller problem areas in the model quickly and cheaply, especially if the surrounding areas in the model are accurate and well defined. Experiences from other State DOTs and the FHWA show that designers can even “cloud” certain area of the 3D model file to indicate that the contractor should not rely on the model in these areas.

When the model conveys the design intent, the model is considered “good enough.” Anecdotally, [this can occur when the model is] 80% complete/accurate. However, taking the model from 80% to 100% can take many times more than the original effort. The intent of this initiative is not to get the models to 100%. Once, in the engineer’s judgment, no substantial additional value would be added to the model, and the model conveys the design intent, the model is “good enough.” There should be sufficient modeling to get accuratex quantities and right of way impacts. Those would be two major issues, if the model wasn't detailed enough for those determinations.

How will this initiative affect survey collection and processing?

Although there may be some changes with respect to software requirements (InRoads vs. OpenRoads), this initiative will have no direct effect on the collection and processing of survey data.

2.0 MODEL DEVELOPMENT THROUGH PROJECT DEVELOPMENT MILESTONES

In general, the development of the 3D model should mirror the development of the plans with focused modeling work to develop and vet alternative designs early in the project and with more detailed and complete modeling work later in the project when the overall footprint is established. When the final plans package is submitted, the goal is for the 3D model and the project plan set to be generally consistent with each other. However, this does not mean designers should attempt to have a complete and accurate 3D model at all times throughout the design of the project.

The following details the amount of graphic detail and information that is to be included in the model at each milestone.

2.1 Scoping Phase

Projects should discuss the scope and uses of the 3D model during development. Designers should begin to develop the model as the line and grade will be set and initial roadway design and hydraulic analysis will have begun.

2.1.1 Establish the Scope of the 3D Model

The model should reflect the final finished surface of the project footprint. The mainline and sidestreet roadways (between shoulder break points) should be well-defined and accurate including intersections and median openings; this includes accurately defining the shoulder break point itself, especially in areas of guardrail and transitions to bridges. The roadside (outside shoulder break points to construction limits) should also be well thought out especially with respect to side slope transitions and roadside safety. The level of precision warranted on the roadside may be less than the roadway due to the nature of the roadside tying into existing ground, however, this is still a very important part of the model given its potential impact to adjacent property and R/W needs.

Not all features are equally important, or provide the same value, to the 3D model. When developing a 3D model, especially during the early phase of implementation when time or resources are limited, this general hierarchy of importance should be used as a prioritization guideline:

- Mainline roadway within shoulder break points including intersections
- Mainline roadside
- Side street roadways within shoulder break points including tie in to mainline
- Side street roadsides
- Bridge endrolls
- Other miscellaneous model details

Any deviations to the LOD of specific elements should be discussed and agreed upon during project scoping. Generally, deviations would include higher levels of LOD; however, there may be cases where lesser levels of LOD may be appropriate for a specific project and element. If a project would benefit in

deviations from LODs as specified in Appendix A, the District L&D Engineer must inform the State L&D Engineer to allow for deviations to be tracked and evaluated for future use and incorporation into this manual.

2.2 Preliminary Design Phase

There are two primary objectives during the preliminary design phase:

1. The designer should lay out the roadway geometry with the end goal of a 3D model
2. The reviewing engineer should perform a high level check of the 3D model to ensure there are no major “busts” which would affect the footprint of the project.

The 3D models should be developed and available for utilization at the public hearing (PH) date (Task 40).

The 3D model should be reviewed at this milestone to ease project visualization and decrease error as the design progresses in detail. Verifying the project footprint and potential R/W impacts is the primary objective of reviewing the 3D model in preliminary design.

2.2.1 Establish 3D Model Uses for Public Engagement

An important effort during public engagement is to discuss how the 3D model will be used in both project development and delivery including public hearings, or team meetings. 3D modeling/visualization tools shall be used to show project concepts in three dimensions, or using graphical tools to the same effect, during public stakeholder meetings. Thoughtful consideration should be given to how the model can be and should be used to engage public stakeholders. Projects should be evaluated for their potential to receive comments due to their complexity, sensitivity, or uniqueness. These types of projects should leverage the 3D model to develop VR drive-through, Fly over, or otherwise tour the project. There are many delivery systems for these 3D designs.

If allowing the user to explore the model freely is desired additional licenses may be required for SAAS products such as SketchFab. This delivery method allows the user to look at what is important to them and provide important feedback about the design. Alternatively, prerecorded videos can be hosted on YouTube and embedded on the VDOT project page or played on loop at a public hearings.

It should be decided if the user will have control over where to look or if they are free to look around the as the video plays:

- The user determines where to look:
 - Record and export 360 degree equirectangular video at a minimum of 4K or preferably 8K.
- The user is shown a predefined video:
 - Record and export video at 1080P or 4K recording is preferable.

Computer monitors are capable of conveying 3D content and can be stationed at public meetings that allow for more intimate interaction in place of traditional 2D plan sets on poster board. Additionally, VDOT's Office of Strategic Innovation has Virtual Reality headsets that can be borrowed for public involvement/engagement meetings. The headsets can access YouTube and play VR video. With a VR headset the user is able look around the scene intuitively. It is advisable that the user be seated as some people lose their balance when placed in VR.

Lastly, 3D printing is another method for deploying 3D content. Additive manufacturing methods like 3D printers work by building up layers to develop the shape of the object. Incorporating a 3D print into a public hearing will allow a very intuitive understanding of what the project will accomplish. Projects that have large vertical elements are best suited for 3D printing such as bridges, tunnels, or roadways with significant elevation differences. VDOT has 3D printers that can be used for producing these models and usually require the model be scaled down significantly and exported in a specified format. These products take several days to produce so contact the Office of Strategic Innovation at least a month before the required date.

2.2.2 LOD for Public Hearing Milestone

The following details the amount of information or detail that is to be included at the PH milestone.

- **Level 100 with conceptual geometry**
 - Any **existing** infrastructure including superstructures, substructures, tunnels, approaches, ramps, and overhead sign structures.
 - A higher LOD and additional LOE is required with subsequent design.
 - Any **existing** buildings (external only), local streets, other topographic features required for context.
 - This is the expected final LOD for this portion of the model.
 - Any **proposed** conditions including elements in the structures, roadway, and traffic signals categories.
 - A higher LOD and additional LOE is required with subsequent design.

- **Level 200 with detailed geometry**
 - N/A for this milestone

- **Level 300 with final geometry**
 - The surface terrain DTM of the **existing** conditions.
 - This is the expected final LOD for this portion of the model.

2.3 Detailed Design Phase

The 3D models should be developed and available for utilization at the public hearing date (Task 40). 3D modeling/visualization tools shall be used to show project concepts in three dimensions, or using graphical tools to the same effect, during public stakeholder meetings.

The 3D model should be reviewed at this milestones to ease project visualization and decrease error as the design progresses in detail.

2.3.1 LOD for Field Inspection Milestone

The following details the amount of information or detail that is to be included at the Field Inspection (FI) milestone.

- **Level 100 with conceptual geometry**
 - Any **proposed** conditions including elements in the drainage, lighting and electrical, landscaping, utilities, ITS, traffic signals, and temporary work zones categories
 - A higher LOD and additional LOE is required with subsequent design.
- **Level 200 with detailed geometry**
 - Any **existing** infrastructure previously modeled as 100 level
 - This is the expected final LOD for this portion of the model.
 - Any **proposed** conditions previously modeled as 100 level
 - A higher LOD and additional LOE is required with subsequent design.
- **Level 300 with final geometry**
 - N/A for this milestone

2.4 Final Design and R/W Acquisition Phase

Final design phase: The primary objective during the final design phase is the refinement of the 3D model in areas with less impact on project footprint but which are still necessary to reflect the design intent, such as refining radius returns. The purpose is to create a 3D model with very few or no areas where the design intent is unclear. For example, if the 3D model contains a few small gaps, point spikes, etc., but the surrounding areas clearly show the design intent, adjustment of these areas is unlikely to add significant value to the model. The model should be reviewed again during the final design phase prior to submission of the final plans package.

2.4.1 LOD for Right-of-Way Milestone

The following details the amount of information or detail that is to be included at the R/W milestone.



- **Level 200 with detailed geometry**
 - Any **proposed** conditions previously modeled as 100 level.
 - This is the expected final LOD for this portion of the model.
- **Level 300 with final geometry**
 - Any **proposed** conditions previously modeled as 200 level.
 - This is the expected final LOD for this portion of the model.

APPENDIX A – Model Elements and Associated Level of Detail

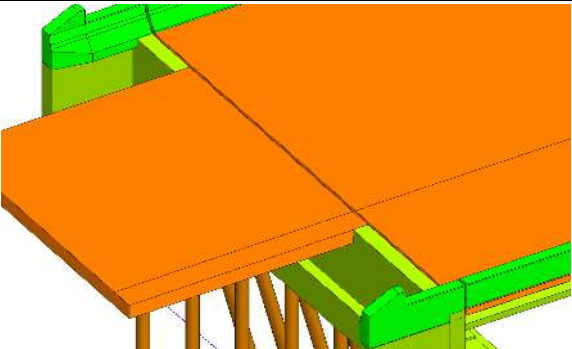
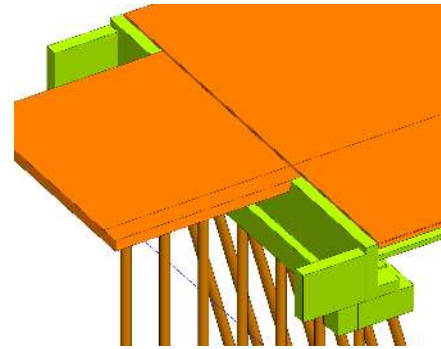
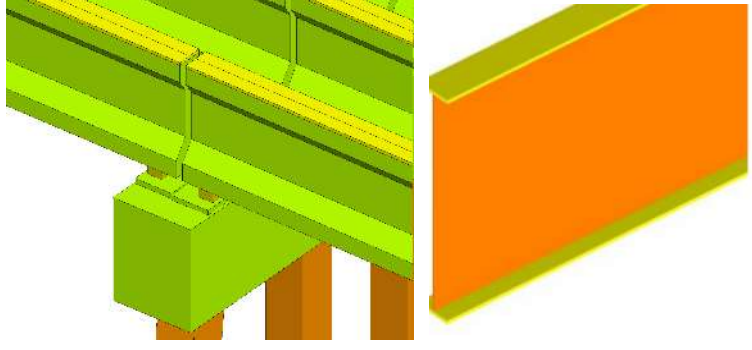
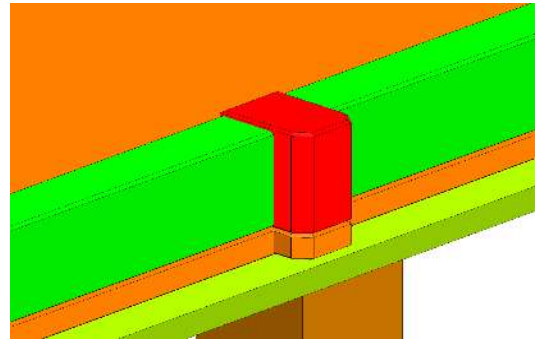
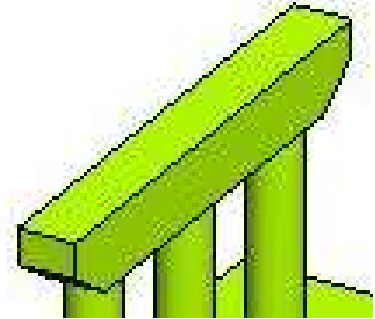

STRUCTURES

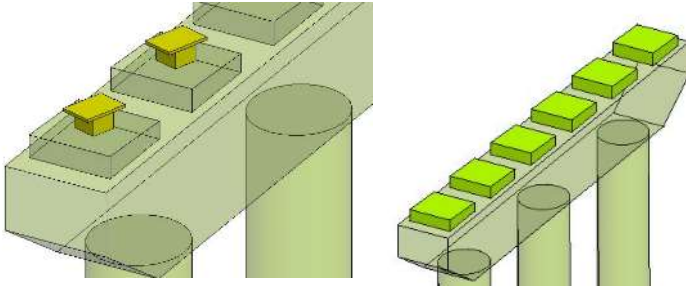
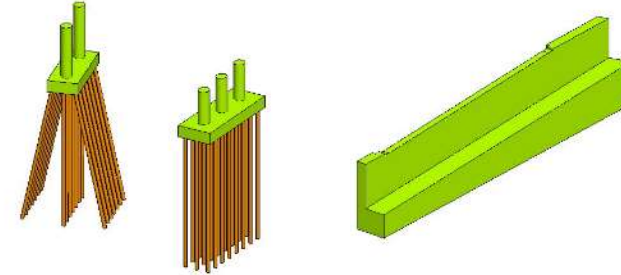
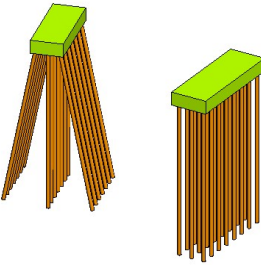
Element	LOD	Modeling Scope	2D Representation	3D Representation	Identification	Info Available
Parapets	300	Transitions in height and shape are accurate at the beginning and end of the transition, but changes to planar faces and lines within the transition are generalized. Detailed notch outs, chamfers, rounding and formwork are not modeled. Elements are not adjusted to incorporate pass through elements (such as conduit) and internal components and connections are not modeled.	Per VDOT CADD standards		-ID -Location from pier to pier	- Standard Type from BD Sheets - Material
Decks	300	Thickness does not incorporate deck fillets. Longitudinal joints, closure pours, turndowns , and expansion joints are not modeled.	Per VDOT CADD standards		-ID -Station range	Offset from base line to deck edge
Girders	300	Camber is not modeled. Detailed notch outs, chamfers, rounding and formwork are not modeled. Splices, bolts, welds, and other detailed assemblies are not modeled. Elements are not adjusted to incorporate pass through elements (such as conduit) and internal components and connections are not modeled.	Per VDOT CADD standards		-ID -Offset location -Pier to pier location*	- Length - Width - Thickness - Height -Material type
Lighting Pole Concrete Pedestal	200	Location, general height, width, and depth are accurate. Detailed component shapes not modeled. Detailed notch outs, chamfers, rounding and formwork are not modeled. Elements are not adjusted to incorporate pass through elements (such as conduit) and internal components and connections are not modeled.	Per VDOT CADD standards			Distance from top of pedestal to top of deck
Pier Caps	300	Beam sets accurate. Detailed notch outs, chamfers, rounding and formwork are not modeled. Elements are not adjusted to incorporate pass through elements (such as conduit) and internal components and connections are not modeled.	Per VDOT CADD standards		-ID -Station	-Top Elevation -Material -Length -Height -Width

STRUCTURES

Element	LOD	Modeling Scope	2D Representation	3D Representation	Identification	Info Available
Bearings / Pedestals	200	Detailed component shapes not modeled Bearings and Pedestals are modeled at accurate spacing and location.	Per VDOT CADD standards		- Bearing Group ID -Associated pier number*	- General Height - Width - Length
Pier Columns	300	Beam sets accurate. Detailed notch outs, chamfers, rounding and formwork are not modeled. Elements are not adjusted to incorporate pass through elements (such as conduit) and internal components and connections are not modeled.	Per VDOT CADD standards		-Column number -Associated pier number	-Diameter - Length - Material
Pier Footings	300	External height, width, and length are accurate. Detailed notch outs, chamfers, rounding and formwork are not modeled. Elements are not adjusted to incorporate pass through elements (such as conduit) and internal components and connections are not modeled.	Per VDOT CADD standards		-Footing Number -Associated Pier Number	- Height - Width - Length -Elevation
Piles	300	Pile shape, top elevation, length, location, embedment, batter are accurate. Any chamfers, fillets, penetrations depressions or openings are not modeled.	Per VDOT CADD standards		-Pile Number within Footing -Associated Pier Number	-Pile shape -Top/Bottom elevation -Length -Location -Embedment -Batter -Material

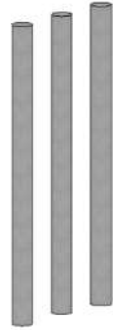
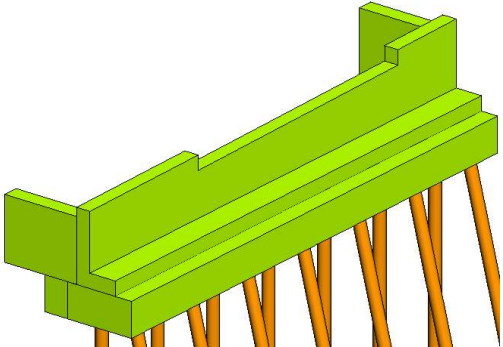
STRUCTURES

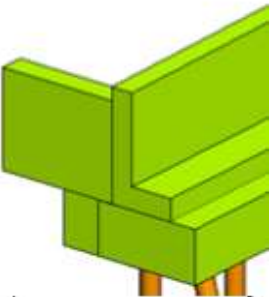
Element	LOD	Modeling Scope	2D Representation	3D Representation	Identification	Info Available
Shafts	300	Column shape, top elevation, length, location, embedment, batter are accurate. Any chamfers, fillets, penetrations depressions or openings are not modeled.	Per VDOT CADD standards		-Shaft Number within Footing -Associated Pier Number	-Pile shape -Top/Bottom elevation -Length -Location -Embedment -Material
Abutments	300	Accurate beam sets. Detailed notch outs, chamfers, rounding and formwork are not modeled. Elements are not adjusted to incorporate pass through elements (such as conduit) and internal components and connections are not modeled.	Per VDOT CADD standards		-Abutment ID -Station*	- Height - Width - Length
Slope Paving	300	Slope paving are modeled to external design geometry, slopes, elevation, and thickness.	Per VDOT CADD standards		Component Feature Name (unique only within each corridor) and Feature definitions	Component Station limits
Wing Walls	300	Detailed notch outs, chamfers, rounding and formwork are not modeled. Elements are not adjusted to incorporate pass through elements (such as conduit) and internal components and connections are not modeled.	Per VDOT CADD standards		-ID -Associated Abutment Number	- Height - Width - Length

STRUCTURES

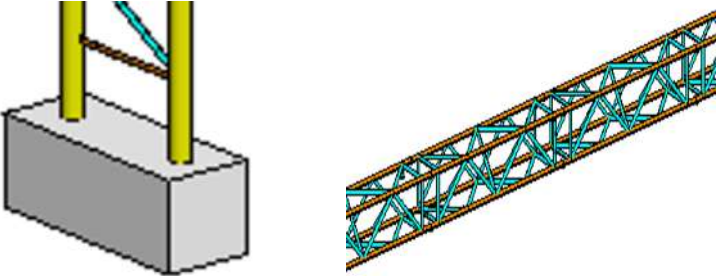
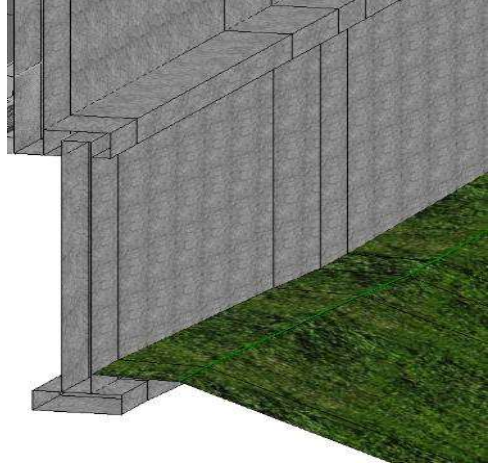
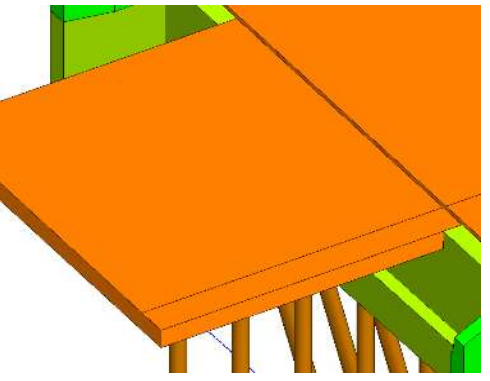
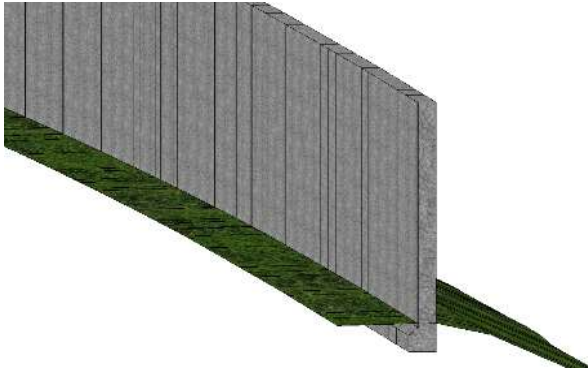
Element	LOD	Modeling Scope	2D Representation	3D Representation	Identification	Info Available
Gantry	300	Gantrys will be accurate to horizontal and vertical location. Internal truss components such as diaphragms and cross bracing and connection details, internal conduit and wiring, and mounted lights may not be modeled. If shown, for visualization purposes only and are not reflective of the design. Footings size, geometry, sloping surface, location are accurate. Chamfers, fillets, wheel holes are not modeled.	Per VDOT CADD standards		Component Feature Name (unique only within each corridor) and Feature definitions	Structure Standard Type
Retaining Walls	300	Retaining Walls will be modeled through the roadway corridor. Finished grade at the face of wall, the top of retained height, and horizontal offset at the face of wall will be accurate. Wall will consist of generic vertical panel and leveling pad for MSE walls, and generic representation of gravity walls. Coping and leveling pad details and steps are not modeled. Reinforcement straps and select fill areas are not modeled. Moment slabs will be modeled through the roadway corridor, accurate to the cross section of the designed moment slab. Individual moment slab panels will not be distinguished. Transitions in height and shape are accurate at the beginning and end of the transition, but changes to planar faces and lines within the transition are generalized. Detailed notch outs, chamfers, rounding and formwork are not modeled. Elements are not adjusted to incorporate pass through or hang on elements (such as conduit) and internal components and connections are not modeled.	Per VDOT CADD standards		Component Feature Name (unique only within each corridor) and Feature definitions	Component Station limits
Approaches	300	Approaches are modeled to external design geometry, slopes, elevation, and thickness through the roadway corridor.	Per VDOT CADD standards		Component Feature Name (unique only within each corridor) and Feature definitions	Component Station limits
Sound Walls	200	Sound Walls will be modeled through the roadway corridor as generic representations. The offset at the face of wall and limits of the sound wall will be accurate. The top of soundwall profile will be accurate to the minimum top of wall profile, but not include steps in panel elevations. Posts and panels will not be modeled.	Per VDOT CADD standards		Component Feature Name (unique only within each corridor) and Feature definitions	Component Station limits

STRUCTURES

Element	LOD	Modeling Scope	2D Representation	3D Representation	Identification	Info Available
Proposed Railings	300	Existing Rail supports are modeled to overall size and approximate geometry. Spacing between railing supports is approximate. Number of supports is approximate. Railing pipe geometry and size are approximate. Models aligned with parapets	Per VDOT CADD standards		-Rail ID -Location from pier to pier -Support ID -Support station	Material
Existing Superstructures	300	Elements of existing superstructures to remain will be modeled to the corresponding LOD and scope for their counterpart proposed items.	Per VDOT CADD standards		As per proposed counterparts	As per proposed counterparts
Existing Substructures	300	Elements of existing substructures to remain will be modeled to the corresponding LOD and scope for their counterpart proposed items.	Per VDOT CADD standards		As per proposed counterparts	As per proposed counterparts

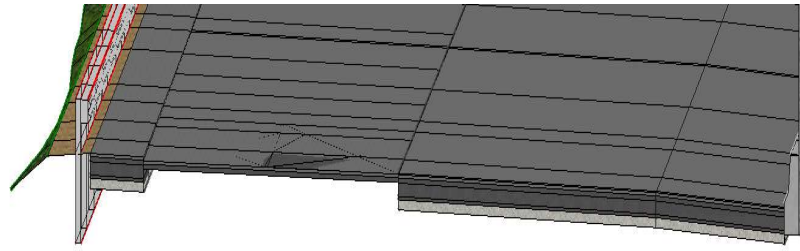
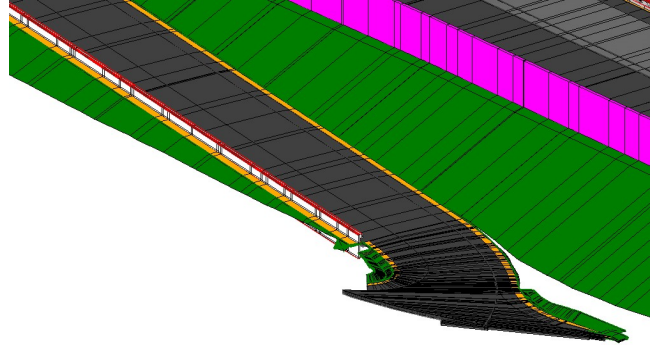
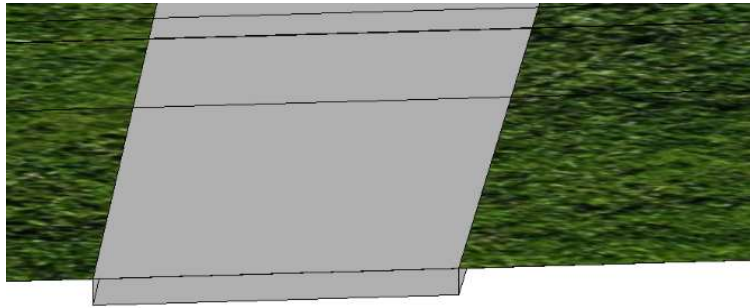
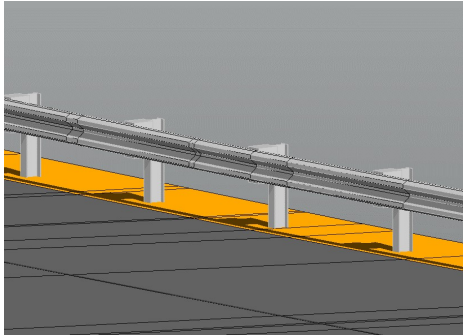
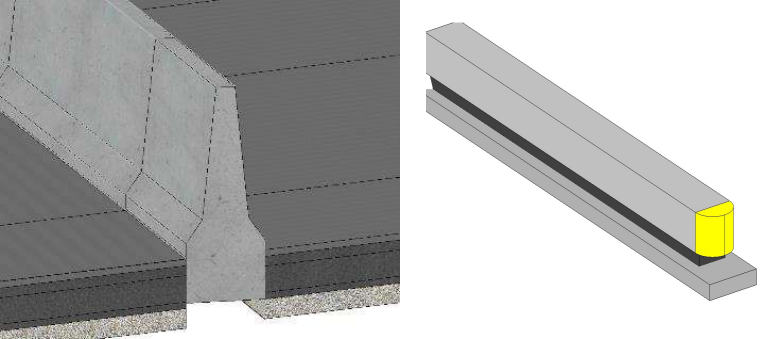
ROADWAY								
Element	LOD	Modeling Scope	2D Representation	3D Representation	Identification	Info Available		
Pavements	300	Pavement structure and shoulder is modeled to external design geometry, slopes, elevation, and thickness. Mill and overlay sections will be modeled to design geometry, slopes, elevation and thickness for finished grade in locations where slope/elevation corrections are being made to existing pavement. The thickness of these locations will be limited to the accuracy of the existing surface terrains. In locations where no slope/elevation correction is being made, the finished grade accuracy will be limited to existing surface terrain. Pavement at corridor limits will match within 0.04' horizontally and vertically.	Per VDOT CADD standards		Component Feature Name (unique only within each corridor) and Feature definitions	Component Station limits		
Ramps	300	Ramps will be modeled to the same LOD as pavements, inclusive of shoulders, curb and gutter, barrier and other roadside appurtenances, each according to their own LOD as specified herein.	Per VDOT CADD standards		Component Feature Name (unique only within each corridor) and Feature definitions	Component Station limits		
Sidewalks	300	Sidewalk structure is modeled to external design geometry, slopes, elevation and thickness.	Per VDOT CADD standards		Component Feature Name (unique only within each corridor) and Feature definitions	Component Station limits		
Guardrail	300	Guardrail and related appurtenances will be modeled using the linestyles 3D GRail Post -Right/Left. Details such as post spacing modifications, reflective devices, individual rail segments, connections and fasteners, will not be modeled. Terminals will not be differentiated instead they will be represented as guardrail continued to the terminal limits in the model.	Per VDOT CADD standards		Component Feature Name (unique only within each corridor) and Feature definitions	Component Station limits		
Other Roadway Safety Features	300	Attenuators will be represented as generalized cells in the correct location, with accurate general external geometry for overall length and width and height. Roadway surfaces will not be warped to meet the generalized attenuator pad. Barrier walls will accurately reflect cross sectional shape, height and length of typical barrier section for a given type. Transitions in height and shape are accurate at the beginning and end of the transition, but changes to planar faces and lines within the transition are generalized. Detailed notch outs, chamfers, rounding and formwork are not modeled. Elements are not adjusted to incorporate pass through or hang on elements (such as conduit) and internal components and connections are not modeled.	Per VDOT CADD standards		Component Feature Name (unique only within each corridor) and Feature definitions	Component Station limits (items modeled in corridors only)		

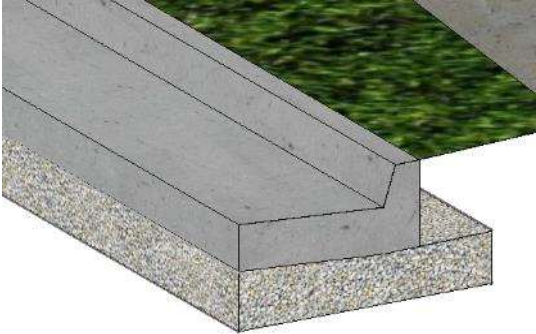
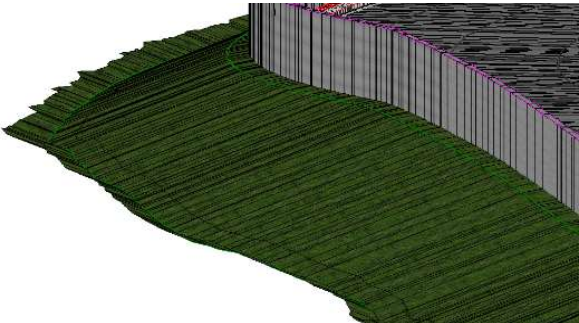
ROADWAY							
Element	LOD	Modeling Scope	2D Representation	3D Representation	Identification	Info Available	
Curb and Gutter	300	Curb and Gutter and bedding material will accurately reflect cross sectional shape, height and length of typical curb and gutter section for a given type. Transitions in height and shape are accurate at the beginning and end of the transition, but changes to planar faces and lines within the transition are generalized. Detailed notch outs, chamfers, rounding and formwork are not modeled.	Per VDOT CADD standards		Component Feature Name (unique only within each corridor) and Feature definitions	Component Station limits	
Grading	300	Proposed grading will accurately reflect plan cross sections and contours of finished grade. Grading between corridor limits will match within 6 inches horizontally and vertically.	Per VDOT CADD standards		Component Feature Name (unique only within each corridor) and Feature definitions	Component Station limits	

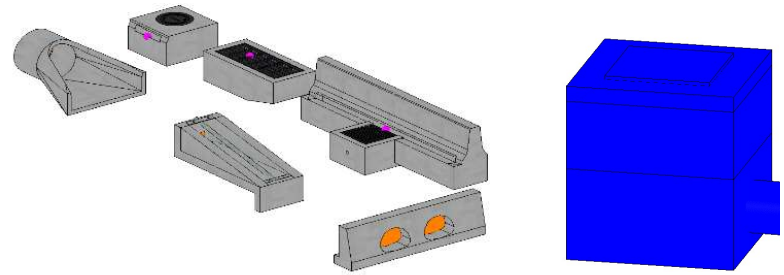
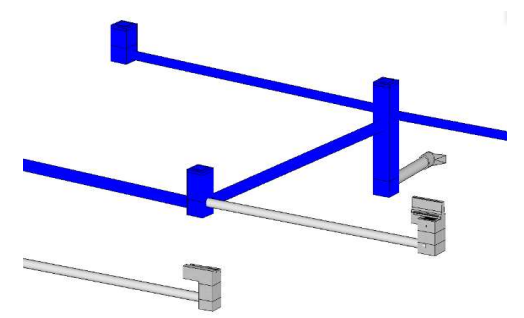
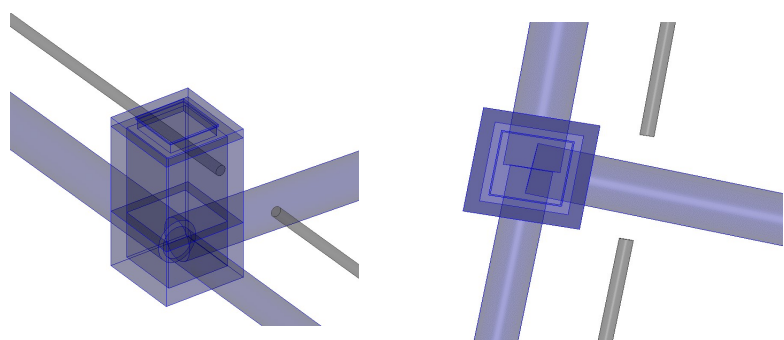
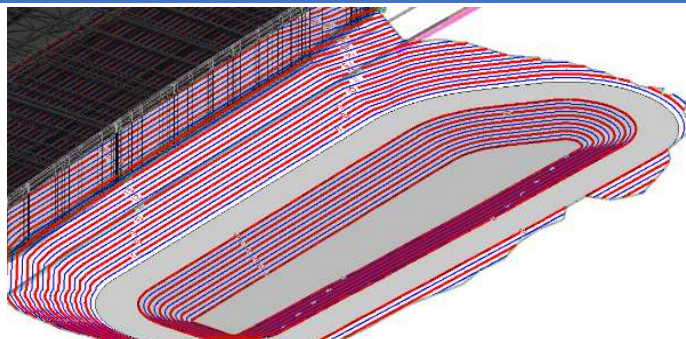
DRAINAGE							
Element	LOD	Modeling Scope	2D Representation	3D Representation	Identification	Info Available	
Drainage Structures	200	Drainage structures will use the prepared 3D cells in the VDOT workspace. The 3D cells will not be scaled or modified, if given cells include barrier, the roadway barrier models will not be reflectively omitted. Structure types that do not exist in the prepared VDOT cell libraries will utilize the closest approximation of the given structure type or a generic cube or cylinder cell will be created. Cell origin points will be horizontally accurate to within 5 feet of the proposed design station and within 6" of proposed offset, and vertically accurate to within 2" of the proposed grade. Orientation of cells will be accurate to within 15 degrees of the proposed design.	Per VDOT CADD standards		feature name (eg. 34-20), element ID (eg. 145906)	feature definition = structure type (eg. D1-14B)	
Drainage Pipes	200	Pipe networks will show the correct inner diameter of pipe, and will be vertically accurate at inverts to within 6" vertically. Pipe lengths will not be adjusted to end at structure walls and instead may continue to the center of structure.	Per VDOT CADD standards		element ID (eg. 145967), feature name = structure ID to structure ID (eg. 34-20to 34-21)	diameter, invert elevations	
Underdrain	200	Underdrain models be generic in nature. Diameter will be correct, but offset and depth will be representative of typical placement. Connections to drainage structures will not be modeled.	Per VDOT CADD standards		element ID (eg. 145967), feature name = structure ID to structure ID (eg. 34-20to 34-21)	diameter	
Basins	200	Basins will reflect plan contours within 1' horizontally and 6" vertically. Grading will not be omitted for pass through objects such as culvert headwalls.	Per VDOT CADD standards		N/A	Contours lines will list their elevation	

Lighting and Electrical

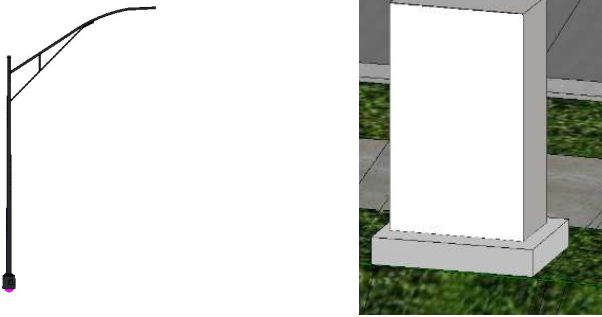
Element	LOD	Modeling Scope	2D Representation	3D Representation	Identification	Info Available
Lightpoles and Lighting Controllers	200	Light pole and lighting controller models will use the prepared 3D cells in the VDOT workspace. Either Twin Arm, Single Arm, and High Mount will be used, whichever closest reflects the designed light pole. The 3D cells will not be scaled or modified, including but not limited to height adjustments and creation of foundations. Cell origin points will be horizontally accurate to within 10 feet of the proposed design, and vertically accurate to within 1 ft of the proposed grading. Orientation of cells will be accurate to within 15 degrees of the proposed design. Conduit and cable will not be modeled.	Per VDOT CADD standards	 The 3D representation column contains two images. On the left is a 2D wireframe model of a light pole with a single arm that curves upwards. On the right is a 3D rendered model of a rectangular lighting controller unit mounted on a concrete base, set against a background of grass and a sidewalk.	XY Coordinates Element ID (eg. 27595)	N/A

LADNDSCAPE AND EROSION CONTROL

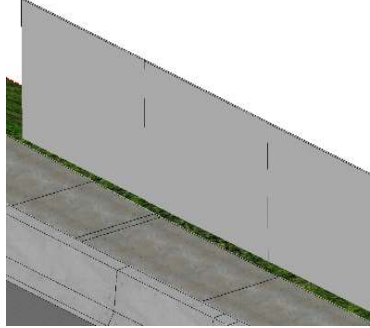
Element	LOD	Modeling Scope	2D Representation	3D Representation	Identification	Info Available
Erosion and sediment control	200	Not to be modeled in 3D.	Per VDOT CADD standards		/	/
Landscaping	200	Google / Bing map background	Per VDOT CADD standards		/	/
Fences	200	Fences will be modeled as extruded or draped generic components. Post and panels will not be differentiated.	Per VDOT CADD standards		element ID (eg. 145967)	N/A

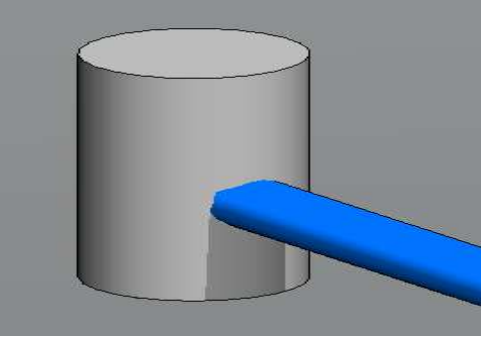
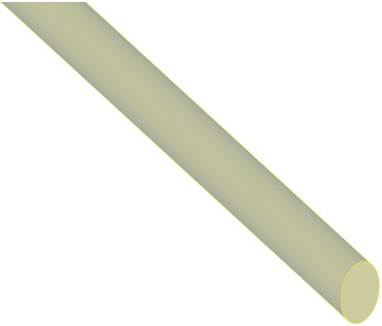
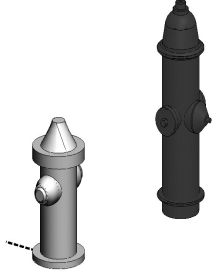
UTILITIES						
Element	LOD	Modeling Scope	2D Representation	3D Representation	Identification	Info Available
Proposed Utility Structures	200	Valves, boxes, and meters will not be modeled. Handholes and manholes will be modeled as simple cylinders or boxes.	Per VDOT CADD standards		feature name (eg. 34-20), element ID (eg. 145906)	feature definition = structure type (eg. D1-14B)
Proposed Utility Pipe	200	Utility pipe models will be general and utilize 2D line work as average assumed depth drapes from existing or proposed surfaces as applicable.	Per VDOT CADD standards		Element ID (eg. 145967), feature name = structure ID to structure ID (eg. 34-20to 34-21)	diameter, invert elevations
Proposed Fire Standpipe systems	200	Standpipe systems will use the prepared 3D cells in the VDOT workspace. The 3D cells will not be scaled or modified. Cell origin points will be horizontally accurate to within 1 feet of the proposed design, and vertically accurate to within 6 inches of the proposed grading. Orientation of cells will not be adjusted.	Per VDOT CADD standards		XY Coordinates Element ID (eg. 27595)	N/A

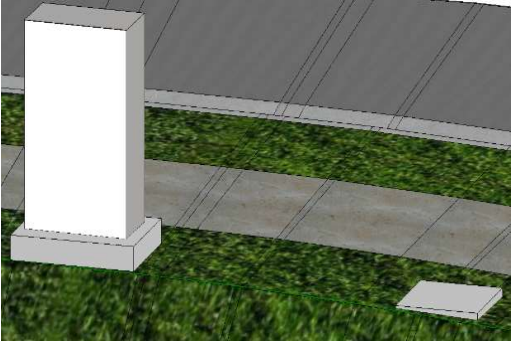
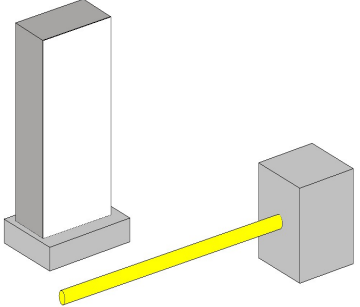
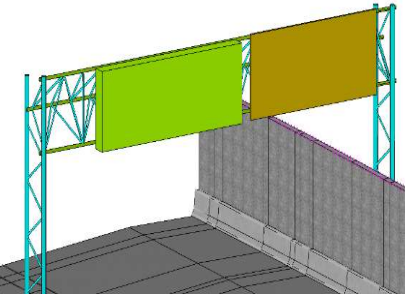
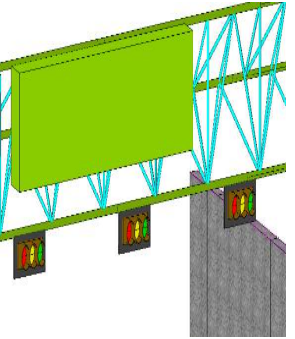
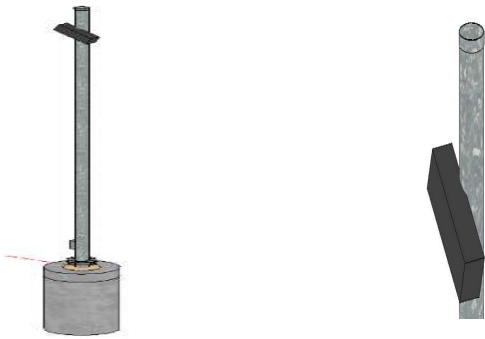
ITS							
Element	LOD	Modeling Scope	2D Representation	3D Representation	Identification	Info Available	
Manholes, Boxes exterior generators and cabinets	200	Boxes, manholes and exterior generators and cabinets will be modeled as simple cylinders or boxes with approximate foundation shapes.	Per VDOT CADD standards		XY Coordinates Element ID (eg. 27595), cell name will reflect type of object	N/A	
Conduit	200	ITS conduit models will be representative, generally following plan location at avg proposed depth. Conduit will be shown as a single pipe element reflective of the duct bank shape rather than individual conduits, with distinction between concrete encased sections and buried sections. Connections, splices, turns, and stub ups at boxes, handholes, cabinets, gantries and other equipment will not be detailed.	Per VDOT CADD standards		XY Coordinates element ID (eg. 145967)	Diameter	
DMS Signs	200	3D modeling of DMS signs will consist of generic sign models at approximate locations. Signs will not include lettering or imagery.	Per VDOT CADD standards		XY Coordinates Element ID (eg. 27595), Cell name will reflect type of DMS sign	N/A	
Lane Use Signals	200	3D modeling of signs will consist of generic signal panels at approximate locations on gantries.	Per VDOT CADD standards		Element ID (eg. 27595)	N/A	
Poles and Mounted Equipment	200	Poles will be modeled as generic representations approximate to location, orientation, hieght, and the foundation depth, with generalized modeling of mounted equipment such as cameras, microwave detectors, Over Height Vehicle Detectors, Annunciators and Beacons. Conduit and cable to poles and devices will not be modeled.	Per VDOT CADD standards		XY Coordinates Element ID (eg. 27595), Cell name will reflect type of pole	N/A	

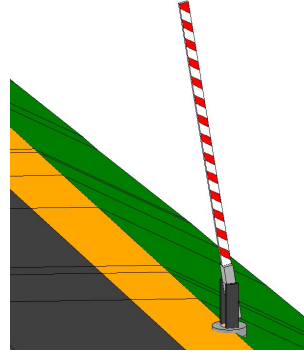
ITS							
Element	LOD	Modeling Scope	2D Representation	3D Representation	Identification	Info Available	
Gates	200	Gates will be modeled as generic representations approximate to location, orientation, hieght, and the foundation depth, with generalized modeling of equipment. Conduit and cable to gates and devices will not be modeled.	Per VDOT CADD standards		XY Coordinates Element ID (eg. 27595), Cell name will reflect type of pole	N/A	

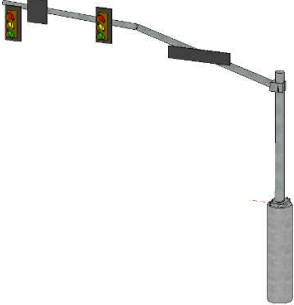
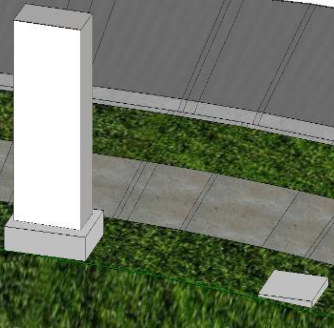
TRAFFIC SIGNALS							
Element	LOD	Modeling Scope	2D Representation	3D Representation	Identification	Info Available	
Signal Poles	300	Traffic Signal poles will be modeled as generic representations accurate to location, orientation, length of mast arm and hieght, and the correct number of signal heads. Foundations will be modeled to accurate width and depth.	Per VDOT CADD standards		XY Coordinates Element ID (eg. 27595), Cell Name will reflect type of Signal Pole	N/A	
Cabinets	200	Cabinets and Handholes and boxes will be modeled as simple cylinders or boxes. Conduit and cable for traffic signals will not be modeled.	Per VDOT CADD standards		XY Coordinates Element ID (eg. 27595)	N/A	

PAVEMENT MARKING AND SIGNING

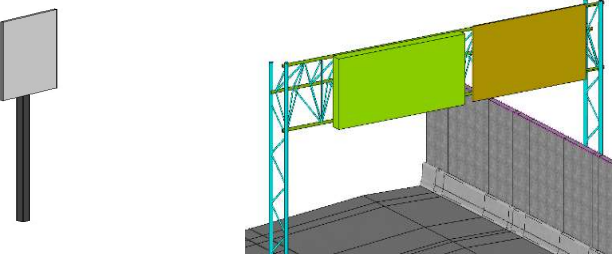
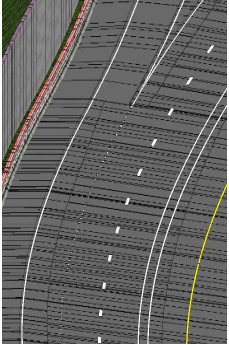
Element	LOD	Modeling Scope	2D Representation	3D Representation	Identification	Info Available
Signage	200	3D modeling of signs will consist of generic sign models at approximate locations. Signs will not include lettering or imagery.	Per VDOT CADD standards		Element ID (eg. 27595)	N/A
Permanent Pavement Marking	200	Pavement Markings will reflect width, spacing, color and location of design, utilizing the stamp function for 2D linework onto 3D corridors.	Per VDOT CADD standards		N/A	N/A

PAVEMENT MARKING AND SIGNING

Element	LOD	Modeling Scope	2D Representation	3D Representation	Identification	Info Available

PAVEMENT MARKING AND SIGNING

Element	LOD	Modeling Scope	2D Representation	3D Representation	Identification	Info Available

PAVEMENT MARKING AND SIGNING

Element	LOD	Modeling Scope	2D Representation	3D Representation	Identification	Info Available

PAVEMENT MARKING AND SIGNING

Element	LOD	Modeling Scope	2D Representation	3D Representation	Identification	Info Available

PAVEMENT MARKING AND SIGNING

Element	LOD	Modeling Scope	2D Representation	3D Representation	Identification	Info Available

PAVEMENT MARKING AND SIGNING



Element	LOD	Modeling Scope	2D Representation	3D Representation	Identification	Info Available





PAVEMENT MARKING AND SIGNING

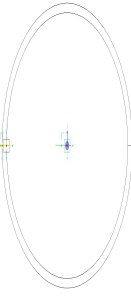
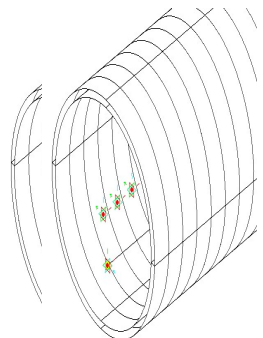
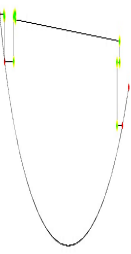
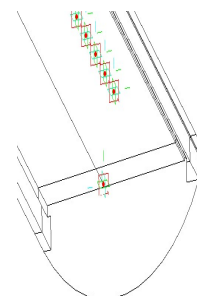

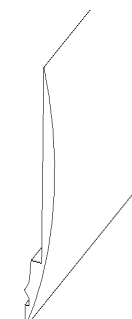
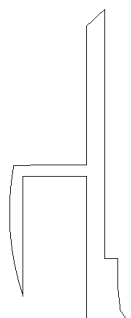
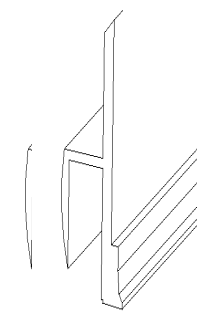
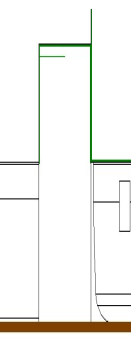
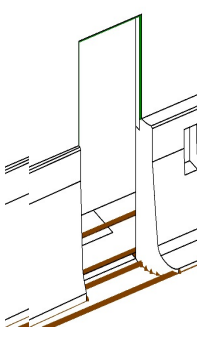
Element	LOD	Modeling Scope	2D Representation	3D Representation	Identification	Info Available

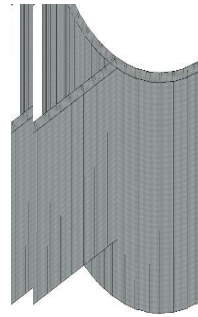

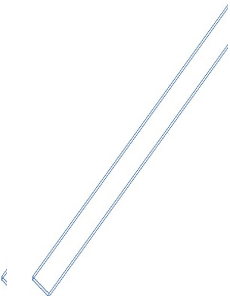
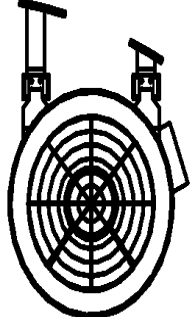
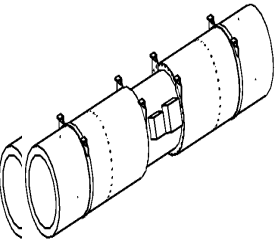
PAVEMENT MARKING AND SIGNING

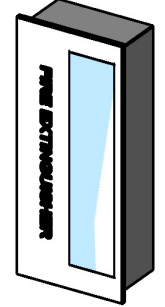
Element	LOD	Modeling Scope	2D Representation	3D Representation	Identification	Info Available

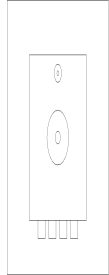
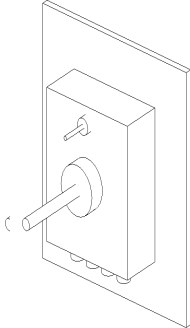
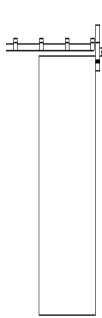
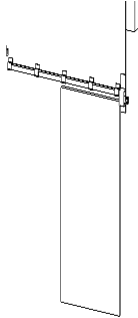

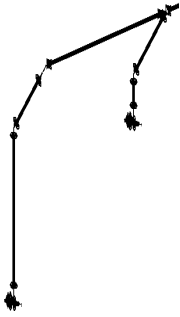
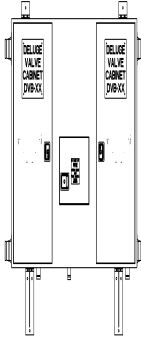
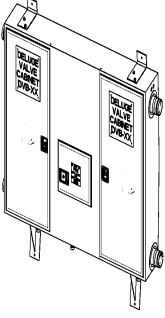

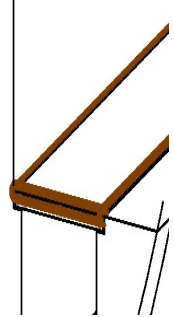
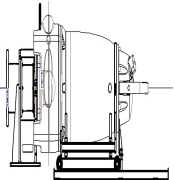
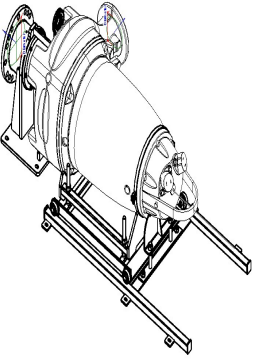
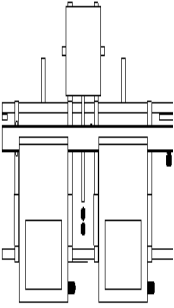
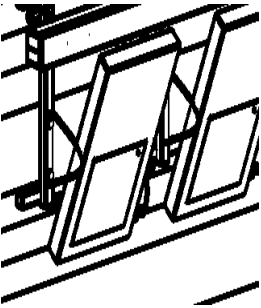
TUNNEL							
Element	LOD	Modeling Scope	2D Representation	3D Representation	Identification	Info Available	
Tunnel Profile	300	Segment modelled individually. All the internal tolerance of the tunnels are integrated			ID	Dimensions (Outer and Inner Diameters, ring segment width) materials Segment Type	
Tunnel Slab	300	Slabs will be separated by typical segments. Walkway of the tunnel is included			ID	Dimensions materials	
Tunnel Traffic Barrier	300	GenerativeComponent. One barrier per typical section			ID	Dimensions materials	
Tunnel Egress Corridor Wall	300	GenerativeComponent. One barrier per typical section. Different parts of the walls splitted.			ID	Dimensions materials	
Tunnel Egress Corridor Wall Opening	300	Hole on the structure (not a specific object).			/	No data	

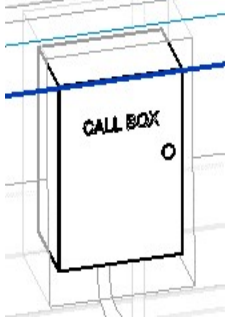

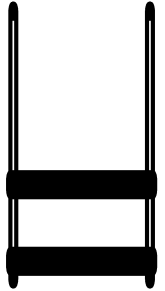
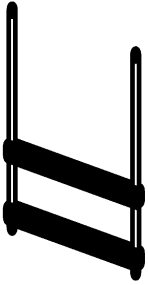

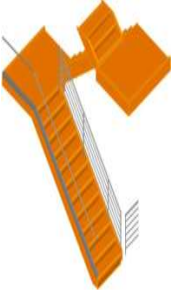
TUNNEL							
Element	LOD	Modeling Scope	2D Representation	3D Representation	Identification	Info Available	
Approach Structure Slurry Wall	300	Each pannel is a single component			ID	Dimensions (width, depth, height) Northing / Easting materials	
Capping beam	300	Contious elements			ID	Dimensions (width, depth, height) materials	
Jet Fan	200	Punctual elements each independent			ID	dimensions manufacturer info model info detail spec	
Fire Extinguisher Cabinet	200	Punctual elements each independent			ID	dimensions manufacturer info model info detail spec	

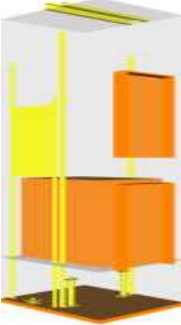
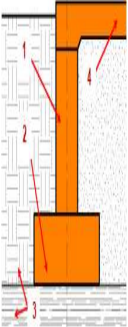
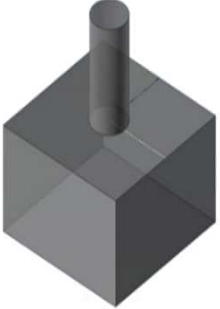

TUNNEL						
Element	LOD	Modeling Scope	2D Representation	3D Representation	Identification	Info Available
Air Quality Sensor	200	Punctual elements each independent			ID	dimensions manufacturer info model info detail spec
Tunnel Egress Corridor Wall Door	200	Punctual elements each independent			ID	dimensions manufacturer info model info detail spec
Sprinkler	200	Punctual elements each independent			ID	dimensions manufacturer info model info detail spec
Equipment	200	Punctual elements each independent			ID	dimensions manufacturer info model info detail spec

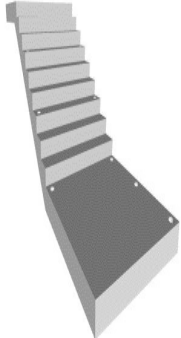
TUNNEL						
Element	LOD	Modeling Scope	2D Representation	3D Representation	Identification	Info Available
Trench Cover	200	Punctual elements each independent			ID	dimensions manufacturer info model info detail spec
Pump and Other Equipments	200	Punctual elements each independent			ID	dimensions manufacturer info model info detail spec
Lighting	200	Punctual elements each independent			ID	dimensions manufacturer info model info detail spec
Equipment	200	Punctual elements each independent			ID	dimensions manufacturer info model info detail spec

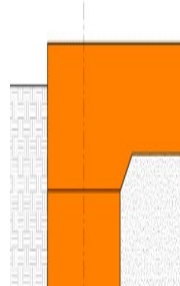
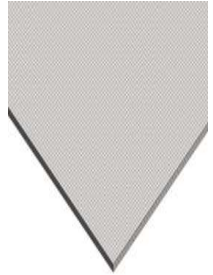

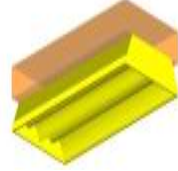

TUNNEL							
Element	LOD	Modeling Scope	2D Representation	3D Representation	Identification	Info Available	
Cable Tray	200	Punctual elements each independent			ID	dimensions manufacturer info model info detail spec	

BUILDING							
Element	LOD	Modeling Scope	2D Representation	3D Representation	Identification	Info Available	
Stairs	200	Punctual elements each independent	Per VDOT CADD standards		ID	dimensions detail specs	
Objects (columns & beams)	200	continuous element	Per VDOT CADD standards		ID	dimensions detail specs	
Objects (slabs and walls)	200	per each floor	Per VDOT CADD standards		ID	dimensions detail specs	
Vertical and horizontal systems	200	Punctual elements each independent			ID	dimensions detail specs	
Foundations	200	Punctual elements each independent			ID	dimensions detail specs	

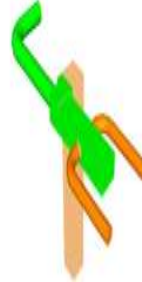
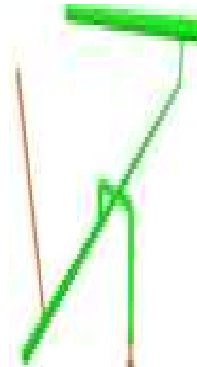
BUILDING							
Element	LOD	Modeling Scope	2D Representation	3D Representation	Identification	Info Available	
Stairs	200	Punctual elements each independent	Per VDOT CADD standards		ID	dimensions detail specs	
Objects (columns & beams)	200	continuous element	Per VDOT CADD standards		ID	dimensions detail specs	
Objects (slabs and walls)	200	per each floor			ID	dimensions detail specs	
Site Preparation	200	per each area	2ft-based contour lines		ID	dimensions detail specs	

BUILDING							
Element	LOD	Modeling Scope	2D Representation	3D Representation	Identification	Info Available	
Site Improvement:	200	per each area	2ft-based contour lines		ID	dimensions detail specs	
Electrical	200	Punctual elements each independent	Per VDOT CADD standards		ID	dimensions detail specs	
Elements (elec. dist)	200	Punctual elements each independent	Per VDOT CADD standards		ID	dimensions detail specs	
Plumbing	200	Punctual elements each independent	Per VDOT CADD standards		ID	dimensions detail specs	

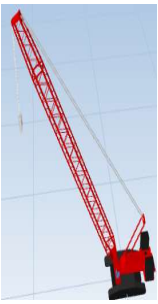
BUILDING							
Element	LOD	Modeling Scope	2D Representation	3D Representation	Identification	Info Available	
Equipment	200	Punctual elements each independent	Per VDOT CADD standards		ID	dimensions detail specs	
distribution, venti	200	Punctual elements each independent	Per VDOT CADD standards		ID	dimensions detail specs	
pression systems.	200	Punctual elements each independent	Per VDOT CADD standards		ID	dimensions detail specs	

TEMPORARY WORK ZONES							
Element	LOD	Modeling Scope	2D Representation	3D Representation	Identification	Info Available	
Work Zones	200	Global volume representing the workzone			/	/	
Barges	200	Global geometry of the element			/	/	
Cranes - Pile Drivers - Equipment	200	Global geometry of the element			/	/	
Temporary Trestle	200	Elements breakdowned as per Structure tab			/	/	
Cofferdams	200	Elements breakdowned as per Structure tab			/	/	

TEMPORARY WORK ZONES							
Element	LOD	Modeling Scope	2D Representation	3D Representation	Identification	Info Available	
Material staging / stockpiles	200	Global volume for representation			/	/	
Construction Entrance	200						
Temporary Items for MOT	200				/	/	