

SECTION 800

TRANSITION CURVES

STANDARD

THIS PAGE INTENTIONALLY LEFT BLANK



ROAD AND BRIDGE STANDARDS

SHEET 1 OF 1

REVISION DATE

TITLE

VIRGINIA DEPARTMENT OF TRANSPORTATION

SPECIFICATION
REFERENCE

2016 ROAD & BRIDGE STANDARDS

STANDARD	TITLE	PAGE
TC-5.11	EXPLANATION OF TABLES AND INSTRUCTIONS FOR USE (GENERAL CONDITIONS)	803.01
	TRANSITION CURVES FOR RURAL AND URBAN HIGHWAYS AND STREET CONDITIONS	803.02
	EXPLANATION OF TABLES AND INSTRUCTIONS FOR USE (RURAL CONDITIONS)	803.03
	EXPLANATION OF TABLES AND INSTRUCTIONS FOR USE (URBAN CONDITIONS)	803.04
	DETAIL FOR TRANSITIONED β RURAL CONDITION WITH PAVEMENT WIDENING	803.05
	DETAIL FOR NON-TRANSITION β URBAN AND RURAL CONDITIONS W/OUT PAVEMENT WIDENING	803.06
	DETAIL OF SUPERELEVATION ABOUT BASELINE	803.07
	DETAIL OF SUPERELEVATION ABOUT BASELINE	803.08
	EXAMPLE FOR FOUR LANE ROADWAYS	803.09
	CROSS SECTION - FOUR LANE ROADWAY	803.10
	METHOD OF APPLYING TC-5.11 ON COMPOUND CURVES RURAL CONDITIONS WITH PAVEMENT WIDENING	803.11
	METHOD OF APPLYING TC-5.11 ON REVERSE CURVES RURAL CONDITION WITH PAVEMENT WIDENING	803.12
	METHOD OF APPLYING TC-5.11 ON COMPOUND CURVES URBAN AND RURAL CONDITIONS WITHOUT PAVEMENT WIDENING	803.13
	METHOD OF APPLYING TC-5.11 ON REVERSE CURVES URBAN AND RURAL CONDITIONS WITHOUT PAVEMENT WIDENING	803.14
	CROWN TRANSITION / TANGENT RUNOUT (Lt) TABLE	803.15
	SUPERELEVATION RUNOFF (Lr) TABLE I (URBAN AND RURAL CONDITIONS WITHOUT PAVEMENT WIDENING)	803.16
	SUPERELEVATION RUNOFF (Lr) TABLE II (RURAL CONDITIONS WITH PAVEMENT WIDENING)	803.17
	SHEET INTENTIONALLY LEFT BLANK	803.18
	METHODOLOGIES FOR CALCULATING TC-5.11 VALUES	803.19
	METHODOLOGIES FOR CALCULATING TC-5.11 VALUES	803.20
	METHODOLOGIES FOR CALCULATING TC-5.11 VALUES	803.21
	CALCULATED TC-5.11 EXAMPLES	803.22
	SUMMARY OF STANDARD TC-5.11 ULS URBAN LOW SPEED DESIGN FACTORS	803.23
	TRANSITION CURVES - URBAN 20 MPH DESIGN SPEED	803.24
	TRANSITION CURVES - URBAN 25 MPH DESIGN SPEED	803.25
	TRANSITION CURVES - URBAN 30 MPH DESIGN SPEED	803.26
	TRANSITION CURVES - URBAN 35 MPH DESIGN SPEED	803.27
	TRANSITION CURVES - URBAN 40 MPH DESIGN SPEED	803.28
	TRANSITION CURVES - URBAN 45 MPH DESIGN SPEED	803.29
	TRANSITION CURVES - URBAN 50 MPH DESIGN SPEED	803.30
	TRANSITION CURVES - URBAN 55 MPH DESIGN SPEED	803.31
	TRANSITION CURVES - RURAL 20 MPH DESIGN SPEED	803.32
	TRANSITION CURVES - RURAL 25 MPH DESIGN SPEED	803.33
	TRANSITION CURVES - RURAL 30 MPH DESIGN SPEED	803.34
	TRANSITION CURVES - RURAL 35 MPH DESIGN SPEED	803.35
	TRANSITION CURVES - RURAL 40 MPH DESIGN SPEED	803.36

INDEX OF SHEETS
SECTION 800-TRANSITION CURVES

VIRGINIA DEPARTMENT OF TRANSPORTATION



ROAD AND BRIDGE STANDARDS

REVISION DATE	SHEET 1 OF 2
---------------	--------------

7/12

800.01

2016 ROAD & BRIDGE STANDARDS

STANDARD	TITLE	PAGE
TC-5.11	TRANSITION CURVES - RURAL 45 MPH DESIGN SPEED	803.37
	TRANSITION CURVES - RURAL 50 MPH DESIGN SPEED	803.38
	TRANSITION CURVES - RURAL 55 MPH DESIGN SPEED	803.39
	TRANSITION CURVES - RURAL 60 MPH DESIGN SPEED	803.40
	TRANSITION CURVES - RURAL 65 MPH DESIGN SPEED	803.41
	TRANSITION CURVES - RURAL 70 MPH DESIGN SPEED	803.42
	TRANSITION CURVES - RURAL 75 MPH DESIGN SPEED	803.43
	TRANSITION CURVES - RURAL 80 MPH DESIGN SPEED	803.44



ROAD AND BRIDGE STANDARDS

SHEET 2 OF 2

REVISION DATE

800.02

7/12

INDEX OF SHEETS
SECTION 800-TRANSITION CURVES

VIRGINIA DEPARTMENT OF TRANSPORTATION

GENERAL CONDITION

ALL ORIGINAL CROSS SECTIONS SHALL BE TAKEN FROM THE BASELINE AT STATIONS, PLUS FIFTIES, AND UNUSUAL BREAKS IN THE GROUND AS ON TANGENT ALIGNMENT.

WHERE A PART OR ALL OF A SUPERELEVATION TRANSITION CURVE FALLS ON A VERTICAL CURVE, ELEVATIONS ON THE VERTICAL CURVE SHOULD BE COMPUTED FOR THE POSITIONS GIVEN ON SHEET 803.15 FOR CROWN TRANSITIONS, SHEET 803.16 FOR URBAN PROJECTS AND SHEET 803.17 FOR RURAL PROJECTS. THESE ELEVATIONS AND PLUSES SHOULD BE SHOWN ON THE PLANS FOR THE CONVENIENCE OF THE SURVEY PARTY IN STAKING OUT THE PROJECT. THROUGHOUT THESE SECTIONS OF THE GRADE, ELEVATIONS AT EVEN STATIONS AND PLUS FIFTIES SHOULD BE OMITTED.

SLOPE STAKES SHOULD BE SET AT THE POSITIONS ON THE TRANSITION GIVEN ON SHEETS 803.15, 803.16 AND 803.17 AND GROUND CROSS SECTIONS TAKEN AT THESE POSITIONS OMITTING THE STATIONS AND PLUS FIFTIES THROUGHOUT THE TRANSITION. IF UNUSUAL BREAKS IN THE GROUND OCCUR, ADDITIONAL SECTIONS SHOULD, OF COURSE, BE TAKEN. ADDITIONAL SECTIONS SHOULD ALSO BE TAKEN WHERE LOCATION IS THROUGH ROCK CUT IN ANTICIPATION OF UNUSUAL BREAKAGE WHICH MAY OCCUR DURING CONSTRUCTION.

AFTER ROUGH GRADING HAS BEEN DONE, FINE GRADING (BLUE TOP) AND FORM STAKES SHOULD BE SET AT THE POSITIONS GIVEN ON SHEET 803.15 FOR CROWN TRANSITIONS, SHEET 803.16 FOR URBAN PROJECTS OR AS GIVEN ON SHEET 803.17 FOR RURAL PROJECTS.

FINAL CROSS SECTIONS SHOULD, OF COURSE, BE TAKEN AT THOSE POSITIONS AT WHICH THE SLOPE STAKE SECTIONS WERE TAKEN. WHERE UNUSUAL BREAKAGE IN ROCK OCCURS, AND THIS WAS NOT ANTICIPATED, ADDITIONAL FINAL SECTIONS SHOULD BE TAKEN AND ORIGINAL GROUND SECTIONS INTERPOLATED.

BASELINE STAKES SHOULD BE SET AT ALL P.C.'S, P.T.'S, T.S.'S, S.T.'S, S.C.'S, AND C.S.'S IN STAKING OUT ALIGNMENT BUT SLOPE STAKES NEED NOT BE SET NOR CROSS SECTIONS TAKEN AT P.C.'S OR P.T.'S EXCEPT WHERE CALLED FOR IN THE ACCOMPANYING TABLES. THE TRANSITION WILL TAKE ITS FORM FROM THE POSITIONS GIVEN ON SHEETS 803.16 AND 803.17.

THE RIGHT OF WAY SHALL, IN ALL CASES, BE REFERENCED FROM THE BASELINE.

THE DESIGNER SHOULD EXERCISE CAUTION IN THE USE OF COMPOUND AND REVERSE CURVES UNLESS TOPOGRAPHICAL OR RIGHT OF WAY RESTRICTIONS MAKE THEIR USE APPROPRIATE. THE USE OF BROKEN-BACK CURVES SHOULD BE AVOIDED EXCEPT WHERE VERY UNUSUAL TOPOGRAPHICAL OR RIGHT OF WAY CONDITIONS MAKE OTHER ALTERNATIVES IMPRACTICAL. THE USE OF BROKEN-BACK CURVES MAY REQUIRE A DESIGN EXCEPTION FROM THE STATE LOCATION AND DESIGN ENGINEER. SEE SHEETS 803.11 THRU 803.14 FOR GENERAL INFORMATION ON COMPOUND, REVERSE AND BROKEN-BACK CURVE INFORMATION.

A DESIGN EXCEPTION IS NOT REQUIRED WHEN USING VALUES FROM SHEETS 803.23 THRU 803.44 SINCE THESE TABLES WERE DERIVED WITHIN AASHTO GUIDELINES.

REFER TO CHAPTER 4 OF AASHTO'S A POLICY ON GEOMETRIC DESIGN OF HIGHWAYS AND STREETS FOR INFORMATION ON THE USE OF 18' PAVEMENT WIDTHS (9' LANE WIDTHS).

ALL TANGENT RUNOUT SECTION (L_t) VALUES AND SUPERELEVATION RUNOFF LENGTHS (L_r) LISTED IN THE TABLES HAVE BEEN ROUNDED UP TO THE NEAREST FOOT. ALL L_t VALUES ARE BASED ON A 2% CROWN.

SPECIFICATION REFERENCE	<h3 style="margin: 0;">EXPLANATION OF TABLES AND INSTRUCTIONS FOR USE</h3> <h3 style="margin: 0;">GENERAL CONDITIONS</h3> <p style="margin: 0; font-size: small;">VIRGINIA DEPARTMENT OF TRANSPORTATION</p>	 ROAD AND BRIDGE STANDARDS				
		<table border="1" style="width: 100%; border-collapse: collapse;"> <tr> <td style="width: 50%; text-align: center;">REVISION DATE</td> <td style="width: 50%; text-align: center;">SHEET 1 OF 1</td> </tr> <tr> <td colspan="2" style="text-align: center;">803.01</td> </tr> </table>	REVISION DATE	SHEET 1 OF 1	803.01	
REVISION DATE	SHEET 1 OF 1					
803.01						

STANDARD SYMBOLS

LOCATION \mathbb{B}	ALIGNMENT ON WHICH THE PROPOSED RIGHT-OF-WAY AND CONSTRUCTION IS BASED.
STANDARD PAVEMENT.....	THE TYPICAL PAVEMENT SECTION TO BE SHOWN ON THE ROAD PLANS.
P.C.	POINT OF BEGINNING OF BASELINE CIRCULAR CURVE.
P.T.	POINT OF ENDING OF BASELINE CIRCULAR CURVE.
P.C.C.	POINT OF BASELINE COMPOUND CURVATURE.
P.R.C.....	POINT OF BASELINE REVERSE CURVE.
T.S.	POINT OF CHANGE FROM TANGENT TO TRANSITION CURVE. (TANGENT TO SPIRAL)
S.C.	POINT OF CHANGE FROM TRANSITION CURVE TO CIRCULAR CURVE. (SPIRAL TO CIRCULAR)
C.S.	POINT OF CHANGE FROM CIRCULAR CURVE TO TRANSITION CURVE. (CIRCULAR TO SPIRAL)
S.T.	POINT OF CHANGE FROM TRANSITION CURVE TO TANGENT. (SPIRAL TO TANGENT)
RADIUS	RADIUS OF BASELINE CIRCULAR CURVE.
DV	APPROXIMATE MAXIMUM SAFE SPEED IN MILES PER HOUR USING STANDARD RATE OF SUPER-ELEVATION.
NC	APPROXIMATE MAXIMUM SAFE SPEED IN MILES PER HOUR WITH NO SUPERELEVATION. FACTORS APPLY ONLY TO URBAN LOW SPEED CONDITIONS.
Lr	LENGTH OF TRANSITION CURVE MEASURED ALONG BASELINE. WHERE NO TRANSITION CURVE IS APPLIED Lr IS LENGTH OF SUPERELEVATION RUNOFF SECTION.
W OR PW	WIDTH OF STANDARD PAVEMENT.
ZT	DISTANCE FROM TRANSITIONED BASELINE TO EDGES OF TRANSITIONED PAVEMENT
w	MAXIMUM TOTAL PAVEMENT WIDENING.
E	RATE OF SUPERELEVATION.
F	SAFE SIDE FRICTION FACTOR.
S	AMOUNT OF SUPERELEVATION TO BE APPLIED TO THE BASELINE GRADE TO OBTAIN THE ELEVATIONS OF THE EDGES OF TRANSITIONED PAVEMENT.
C	DIFFERENCE IN ELEVATION BETWEEN BASELINE (CENTER) AND EDGE OF PAVEMENT FOR STANDARD PAVEMENT CROWN.
Lt	STANDARD PAVEMENT CROWN TRANSITION OR TANGENT RUNOUT SECTION.
CP	CHORD POINT (1/10 INCREMENTS OF TRANSITION CURVE).
NPC.....	NORMAL PAVEMENT CROWN.

ALL DISTANCES (HORIZONTAL AND VERTICAL) ARE MEASURED IN FEET.



ROAD AND BRIDGE STANDARDS

TRANSITION CURVES FOR RURAL AND URBAN HIGHWAYS AND STREET CONDITIONS

SPECIFICATION
REFERENCE

SHEET 1 OF 1

REVISION DATE

803.02

VIRGINIA DEPARTMENT OF TRANSPORTATION

RURAL CONDITION

RURAL CONDITIONS APPLY TO INTERSTATE, ARTERIAL, PRIMARY AND SECONDARY SYSTEMS OR TO ANY OTHER ROAD WITH RURAL TYPE DESIGN AND OPERATING CONDITIONS.

THESE TABLES CONTAIN THE MINIMUM ALLOWABLE SUPERELEVATION, TRANSITION LENGTHS, AND WIDENING CORRECTIONS FOR STANDARD RURAL PAVEMENT WIDTHS THROUGH A RANGE OF DESIGN VELOCITIES CONSIDERED MOST LIKELY TO BE USED IN RURAL HIGHWAY DESIGN.

DEFINITIONS FOR THE STANDARD SYMBOLS USED THROUGHOUT THESE TABLES ARE FOUND ON SHEET 803.02.

FOR MINIMUM DESIGN FACTORS FOR VARIOUS DESIGN SPEEDS FOR RURAL CONDITIONS SEE SHEETS 803.32 THRU 803.44.

ON CURVES WITH NO PAVEMENT WIDENING. PAVEMENT WILL BE SUPERELEVATED BY AN AMOUNT EQUAL TO THE RATE SHOWN IN THE TABLES. SEE SHEET 803.06 FOR A GRAPHICAL ILLUSTRATION OF THE APPLICATION OF THIS CORRECTION.

ON CURVES WITH PAVEMENT WIDENING, WIDENING WILL BE ACHIEVED BY EQUAL WIDENING OF BOTH EDGES OF PAVEMENT OVER THE SUPERELEVATION RUNOFF LENGTH. SEE PAGE 803.05 FOR DETAILS.

WHEN USING COMPOUND OR REVERSE CURVES WITH RURAL CONDITIONS, SEE SHEETS 803.11, 803.12, 803.13, AND 803.14 FOR DETAILS OF TRANSITIONS.

FOR CURVE RADII NOT LISTED IN TABLES, REFER TO SHEET 803.20 TO CALCULATE SUPERELEVATION RUNOFF LENGTH (L_r) AND PAVEMENT WIDENING (w).

L_r AND E SHALL BE SHOWN ON THE PLANS FOR ALL CURVES.

FOR ADDITIONAL GENERAL INSTRUCTIONS (BOTH URBAN AND RURAL) SEE SHEET 803.01.

SPECIFICATION REFERENCE	EXPLANATION OF TABLES AND INSTRUCTIONS FOR USE RURAL CONDITION	 ROAD AND BRIDGE STANDARDS	
		REVISION DATE	SHEET 1 OF 1
		803.03	

URBAN CONDITION

URBAN CONDITIONS APPLY TO URBAN STREET SYSTEMS AND ANY OTHER ROAD WITH PRESENT OR FUTURE URBAN STREET OPERATING CONDITIONS.

THESE TABLES CONTAIN THE MINIMUM SUPERELEVATION RATES AND TRANSITION LENGTHS FOR STANDARD URBAN PAVEMENT WIDTHS THROUGH A RANGE OF DESIGN VELOCITIES CONSIDERED MOST LIKELY TO BE USED IN URBAN ROAD DESIGN.

DEFINITIONS FOR THE STANDARD SYMBOLS USED THROUGHOUT THESE TABLES ARE FOUND ON SHEET 803.02.

A TABLE FOR "LOW SPEED URBAN" DESIGNS IS ON SHEET 803.23 WITH A RANGE OF STANDARD PAVEMENT WIDTHS (W), TRANSITION LENGTHS (L_r), AND RADII OF CURVE WHEN SUPERELEVATED BY AN AMOUNT EQUAL TO THE NORMAL CROWN AND THE APPROXIMATE MAXIMUM SAFE SPEEDS (DV) AFFORDED THEREBY. VALUES IN THIS TABLE CAN BE USED ON STREETS WITH OPERATING SPEEDS LESS THAN OR EQUAL TO 45 MPH. ALSO SHOWN ARE THE APPROXIMATE MAXIMUM SAFE SPEEDS (NC) WITH NO SUPERELEVATION. VALUES FOR (NC) CAN BE USED ON URBAN ARTERIAL, COLLECTOR, AND LOCAL STREETS.

FOR MINIMUM DESIGN FACTORS FOR VARIOUS DESIGN SPEEDS FOR URBAN CONDITIONS SEE SHEETS 803.24 THRU 803.31

THE USE OF SPIRAL TRANSITIONS FOR COMPOUND AND REVERSE CURVES ON URBAN ROADWAYS SHOULD BE AVOIDED. HOWEVER, THE ENGINEER DOES HAVE LATITUDE IN THE USE OF SPIRAL TRANSITIONS IF THE GEOMETRICS ARE WARRANTED. SHOULD SPIRAL TRANSITIONS BE UTILIZED, SEE PAGE 803.13 AND 803.14 FOR DETAILS. WHEN URBAN CONDITIONS APPLY THERE WILL BE NO PAVEMENT WIDENING. THE LENGTH OF TRANSITION (L_r) DETERMINES THE LENGTH OF SUPERELEVATION TRANSITION THROUGH WHICH THE OUTER EDGE OF PAVEMENT IS RAISED ABOVE THE BASELINE GRADE TO A MAXIMUM OF $E(\frac{W}{2})$. SEE SHEET 803.07 FOR A GRAPHICAL ILLUSTRATION OF THE APPLICATION OF THIS CORRECTION.

FOR CURVE RADII NOT LISTED IN TABLES REFER TO SHEET 803.20 TO CALCULATE TRANSITION LENGTHS (L_r).

L_r SHALL BE SHOWN ON THE PLANS FOR ALL CURVES.

E SHALL BE SHOWN ON THE PLANS FOR ALL CURVES WITH URBAN STREET CONDITIONS.

FOR ADDITIONAL GENERAL INSTRUCTIONS (BOTH URBAN AND RURAL) SEE SHEET 803.01.



ROAD AND BRIDGE STANDARDS

SHEET 1 OF 1

REVISION DATE

803.04

EXPLANATION OF TABLES AND INSTRUCTIONS FOR USE URBAN CONDITION

VIRGINIA DEPARTMENT OF TRANSPORTATION

SPECIFICATION
REFERENCE

CHORD POINTS (CP) = $\frac{L_r}{10}$

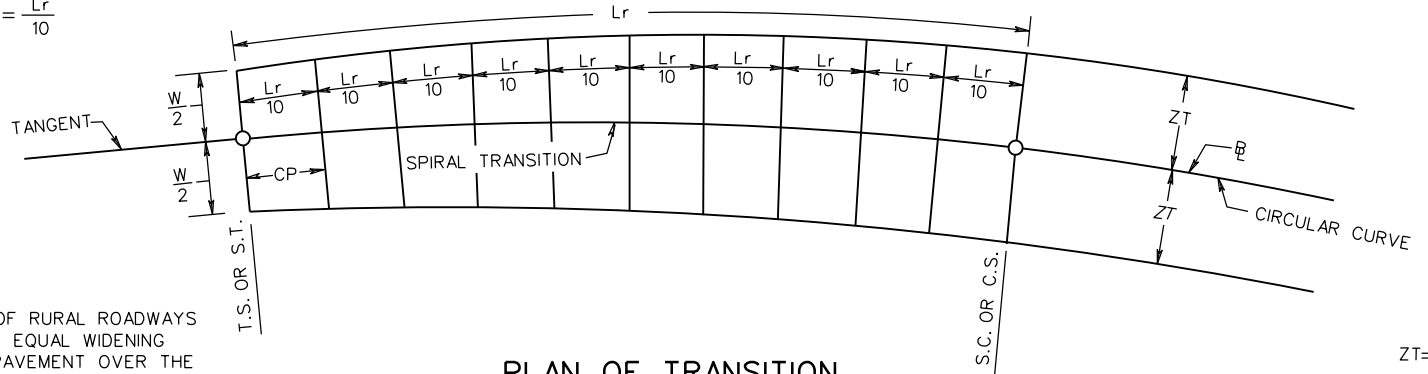

NOTE:

PAVEMENT WIDENING OF RURAL ROADWAYS WILL BE ACHIEVED BY EQUAL WIDENING OF BOTH EDGES OF PAVEMENT OVER THE SUPERELEVATION RUNOFF LENGTH (L_r).

PLAN OF TRANSITION

NOTE:

ON THE INSIDE OF CURVE THE STANDARD PAVEMENT CROWN (C) SHALL BE HELD UNTIL IT IS EXCEEDED BY THE TABULATED (S) VALUE, THEN THE (S) VALUES SHALL BE APPLIED.

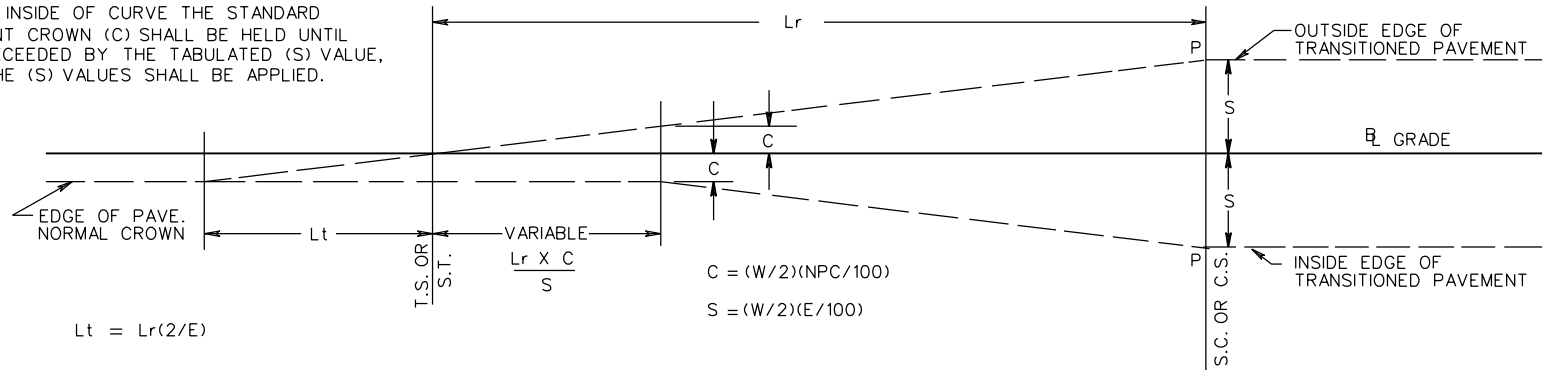

PROFILE OF TRANSITION

NOTE: SHORT VERTICAL CURVES SHOULD BE INSERTED BY EYE AT POINTS (P) IF CONSIDERED NECESSARY.

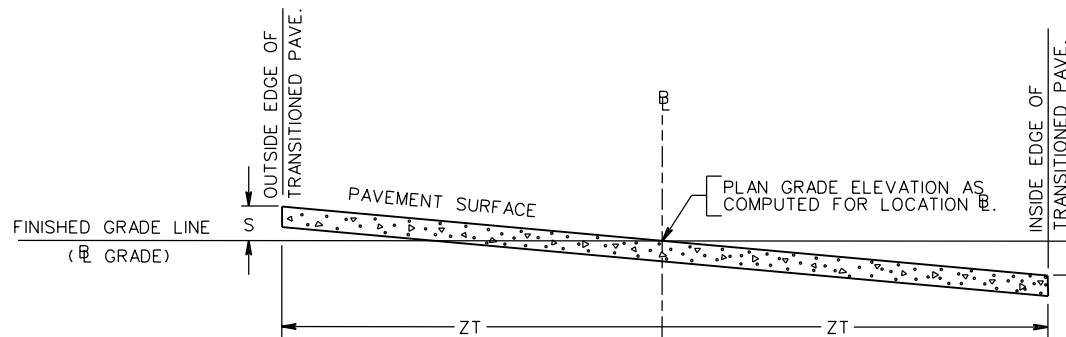

CROSS SECTION THRU TRANSITION

SPECIFICATION REFERENCE

DETAIL FOR TRANSITIONED $\frac{B}{E}$ RURAL CONDITION WITH PAVEMENT WIDENING

VIRGINIA DEPARTMENT OF TRANSPORTATION

VDOT

ROAD AND BRIDGE STANDARDS

REVISION DATE

SHEET 1 OF 1

803.05

TC-5.11

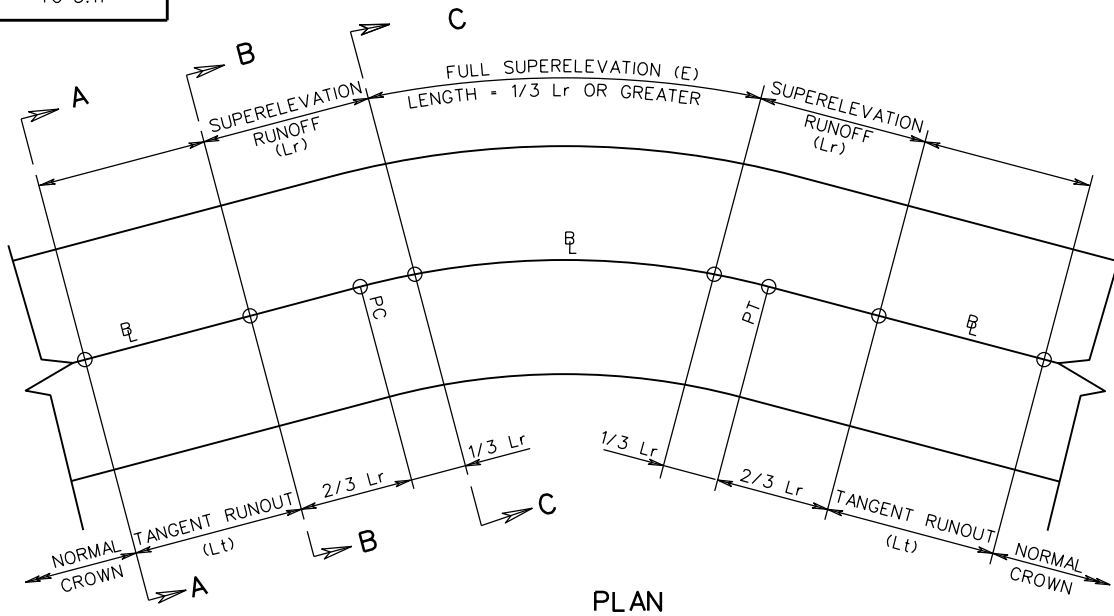

$$L_t = L_r(2/E)$$

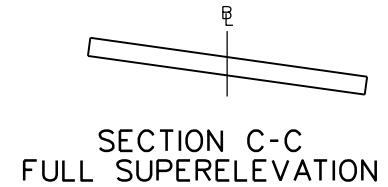
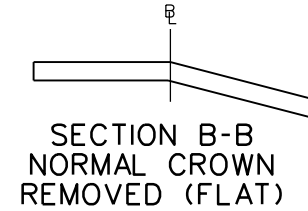
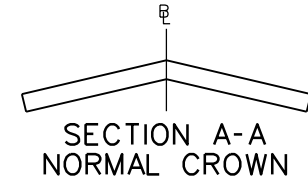

$$C = (W/2)(NPC/100)$$

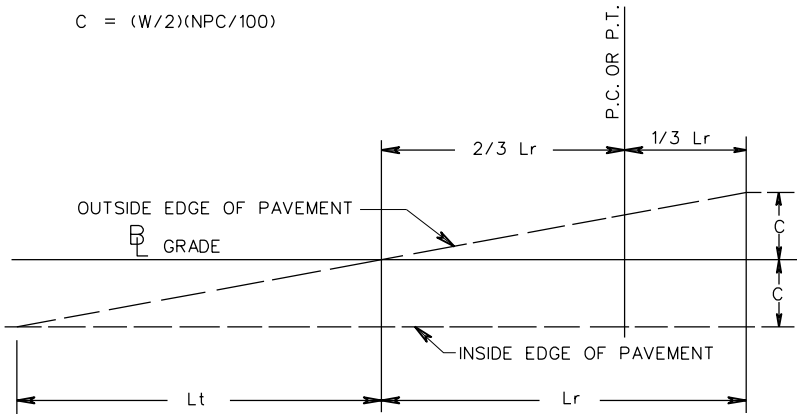

SUPERELEVATED BY AN AMOUNT EQUAL TO THE STANDARD PAVEMENT CROWN

$$C = (W/2)(NPC/100)$$

$$S = (W/2)(E/100)$$

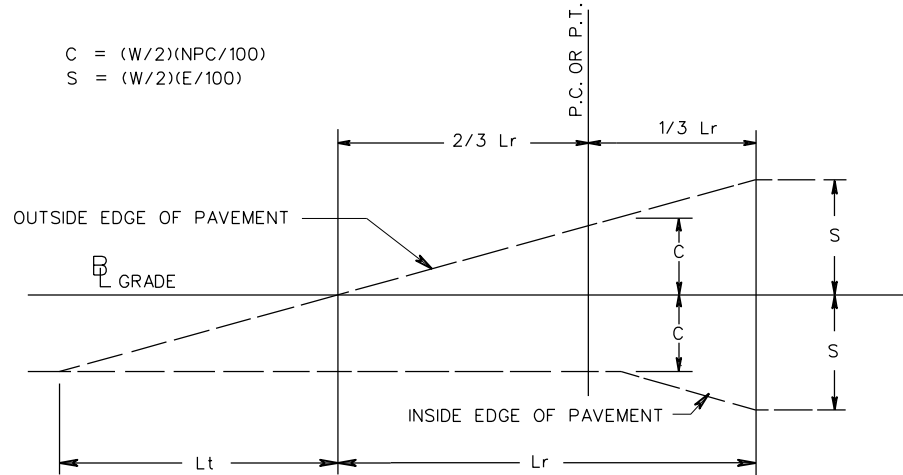

NOTE : ON THE INSIDE OF CURVE THE STANDARD PAVEMENT CROWN (C) SHALL BE HELD UNTIL IT IS EXCEEDED BY THE TABULATED RATE OF SUPERELEVATION (E).

SUPERELEVATED BY AN AMOUNT EXCEEDING THE STANDARD PAVEMENT CROWN



ROAD AND BRIDGE STANDARDS

SHEET 1 OF 1

REVISION DATE

803.06

01/13

DETAIL FOR NON-TRANSITION β URBAN & RURAL
CONDITIONS W/OUT PAVEMENT WIDENING

VIRGINIA DEPARTMENT OF TRANSPORTATION

SPECIFICATION
REFERENCE

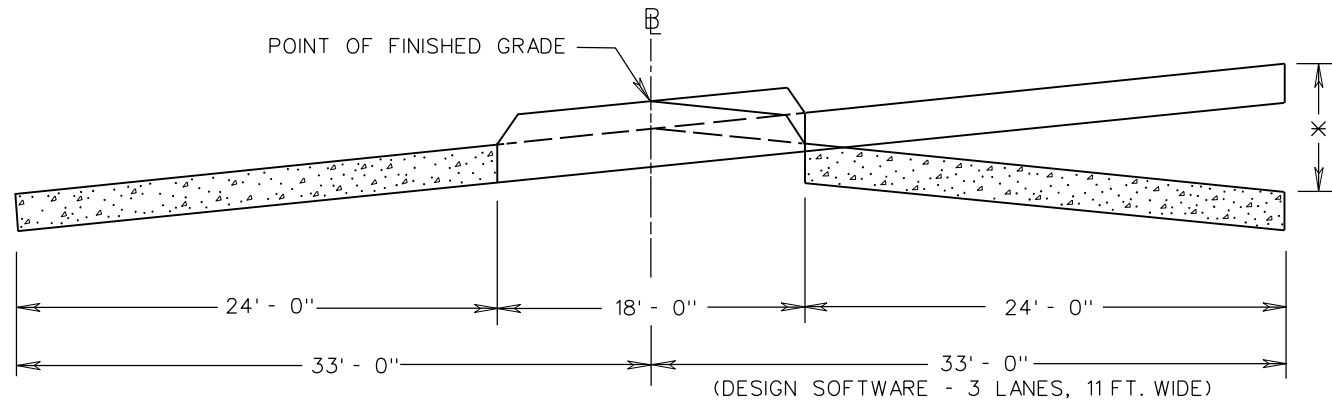
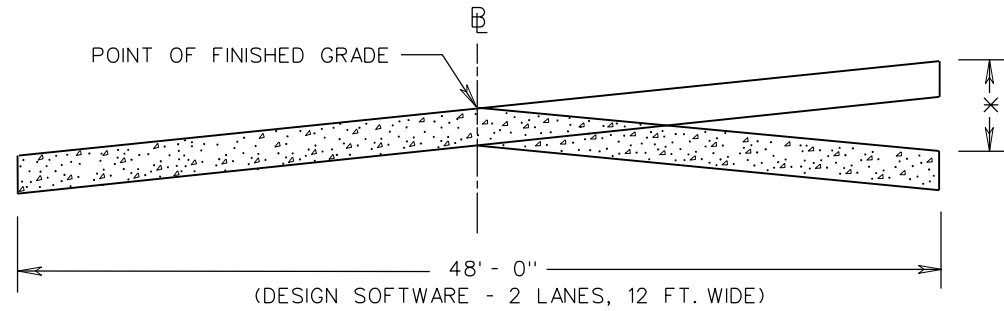

× THE ELEVATION DIFFERENTIAL BETWEEN NORMAL CROWN AND MAXIMUM SUPERELEVATION, RELATIVE TO THE BASELINE PROFILE.

ADDITIONAL INFORMATION MAY BE OBTAINED FROM A POLICY ON GEOMETRIC DESIGN OF HIGHWAYS AND STREETS (AASHTO) BOOK, CHAPTER III - ELEMENTS OF DESIGN (SUPERELEVATION RUNOFF).

ON STANDARD TC-5.11ULS, TC-5.11U , AND TC-5.11R (WITHOUT PAVEMENT WIDENING) SUPERELEVATED CURVES, POSITION THE SUPERELEVATION RUNOFF SECTION (L_r) TWO THIRDS ($2/3$) ON THE TANGENT AND ONE THIRD ($1/3$) INTO THE CURVE. STATIONS AND ELEVATIONS FOR THESE TRANSITIONS WILL NEED TO BE COMPUTED FOR TS, SC, CS, ST AND EVERY 25' INCREMENT (i.e., 10+00, 10+25, 10+50, 10+75, etc...)

SPECIFICATION REFERENCE

DETAILS OF SUPERELEVATION ABOUT BASELINE

VDOT

ROAD AND BRIDGE STANDARDS

REVISION DATE

SHEET 1 OF 1

803.07

VIRGINIA DEPARTMENT OF TRANSPORTATION

TC-5.11

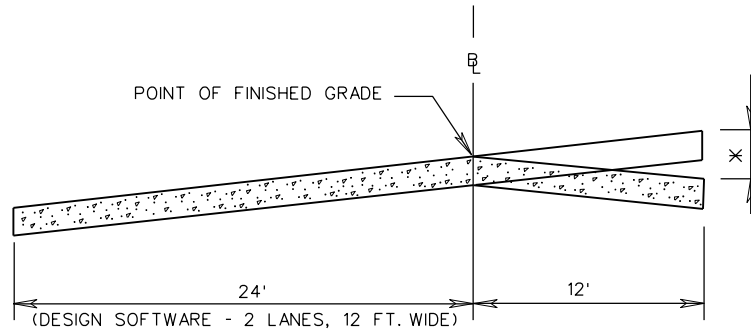

THE PAVEMENT WIDTHS SHOWN IN THE STANDARD TC-5.11 TABLES ON SHEET 803.24 THROUGH 803.44 REPRESENT TWICE THE DISTANCE FROM THE CROWNLINE TO THE EDGE OF PAVEMENT ON THE HIGH SIDE.

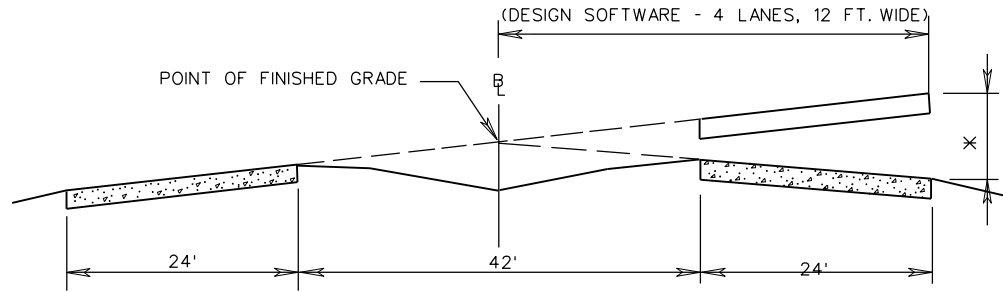

* THE ELEVATION DIFFERENTIAL BETWEEN NORMAL CROWN AND MAXIMUM SUPERELEVATION, RELATIVE TO THE BASELINE PROFILE.

ADDITIONAL INFORMATION MAY BE OBTAINED FROM A POLICY ON GEOMETRIC DESIGN OF HIGHWAYS AND STREETS (AASHTO) BOOK, CHAPTER III - ELEMENTS OF DESIGN (SUPERELEVATION RUNOFF).

PROJECTS IN WHICH LANES MAY BE ADDED IN THE FUTURE IN THE MEDIAN AREA SHOULD BE DESIGNED WITH THE CONSTRUCTION BASELINE AND POINT OF FINISHED GRADE LOCATED IN THE MIDDLE OF THE MEDIAN. SUPERELEVATION IS TO BE ROTATED FROM THIS BASELINE POINT. THIS WILL PREVENT UNEVEN PAVEMENT PROBLEMS (WHEN ADDITIONAL LANES ARE ADDED IN THE MEDIAN AREA) SUCH AS CROSSOVER GRADES AS WELL AS THE NEED FOR RETAINING WALLS, MEDIAN BARRIERS AND SPECIAL DESIGN DRAINAGE STRUCTURES. ADDITIONAL RIGHT OF WAY OR EASEMENTS, IN MOST SITUATIONS, WILL NOT BE REQUIRED.



ROAD AND BRIDGE STANDARDS

SHEET 1 OF 1

REVISION DATE

803.08

DETAILS OF SUPERELEVATION ABOUT BASELINE

VIRGINIA DEPARTMENT OF TRANSPORTATION

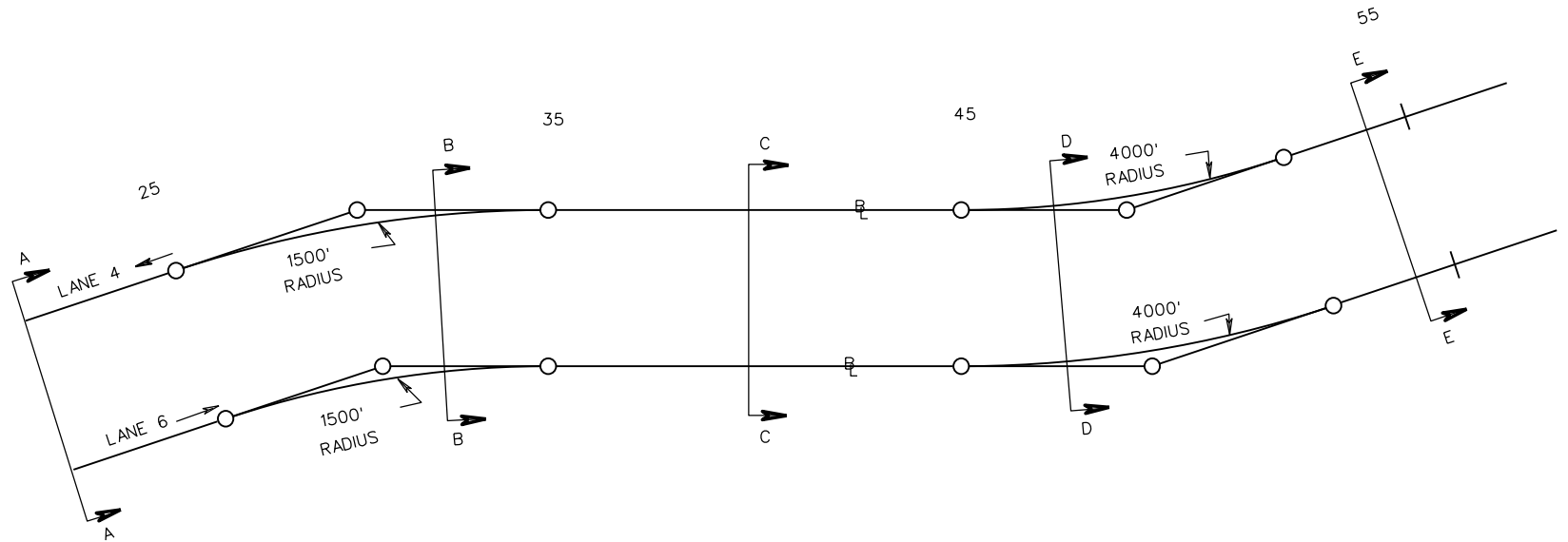

SPECIFICATION
REFERENCE

EXAMPLE FOR FOUR LANE ROADWAYS

VDOT

ROAD AND BRIDGE STANDARDS

REVISION DATE

SHEET 1 OF 1

803.09

VIRGINIA DEPARTMENT OF TRANSPORTATION

TC-5.11

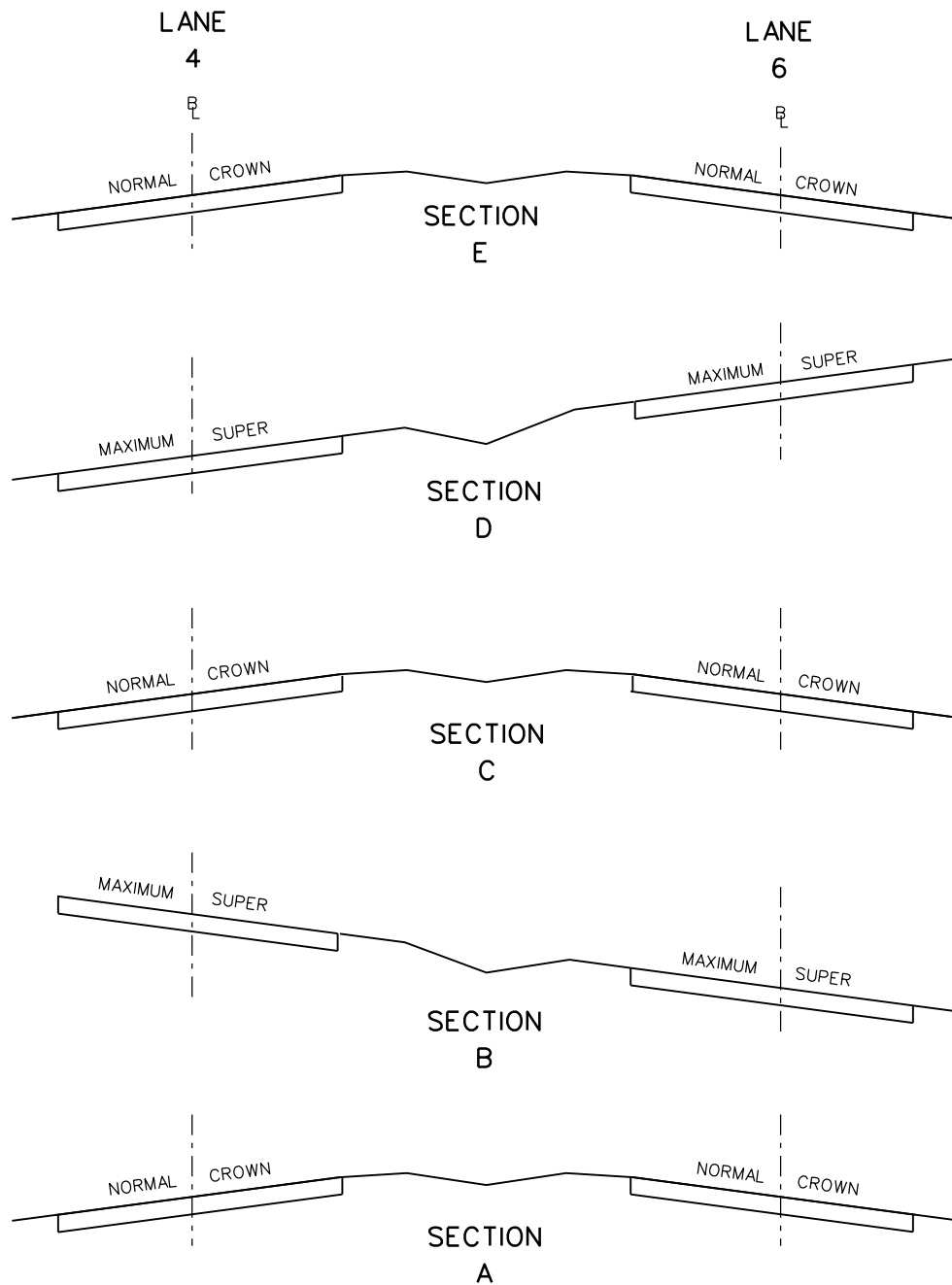

ROAD AND BRIDGE STANDARDS

SHEET 1 OF 1

REVISION DATE

803.10

CROSS SECTION - FOUR LANE ROADWAY

VIRGINIA DEPARTMENT OF TRANSPORTATION

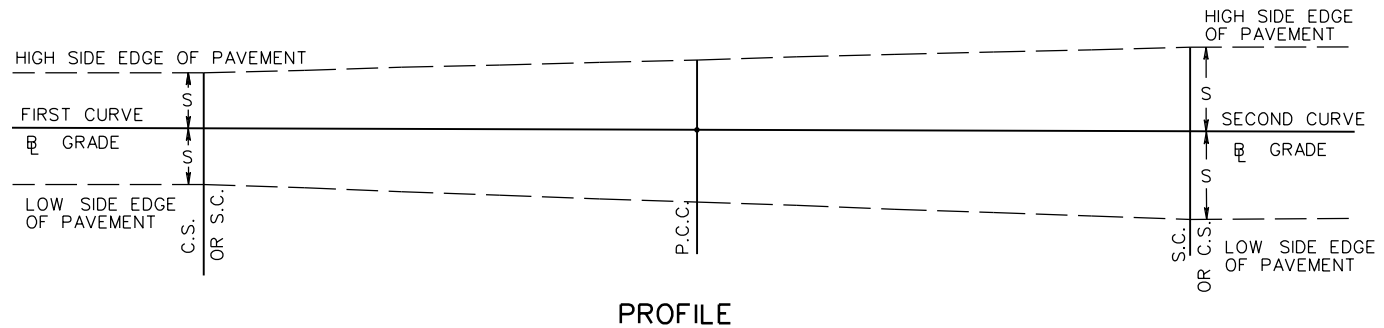
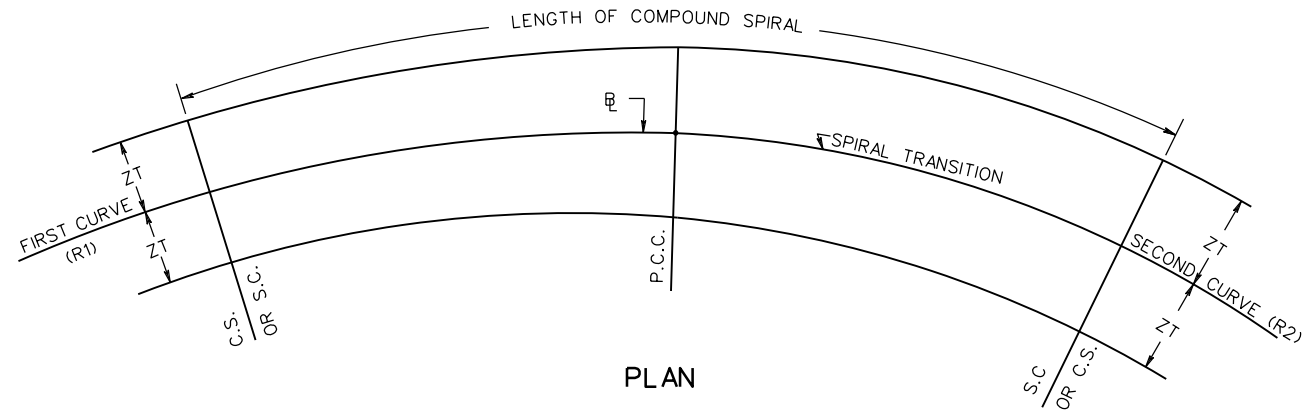

NOTE:

1. FOR COMPOUND CURVES ON OPEN ROADWAYS, THE RATIO OF FLATTER RADIUS (R1) TO THE SHARPER RADIUS (R2) SHALL NOT EXCEED 1.5:1.
2. FOR COMPOUND CURVES ON RAMPS AND AT INTERSECTIONS, THE RATIO OF THE FLATTER RADIUS (R1) TO THE SHARPER RADIUS (R2) SHALL NOT EXCEED 2:1. WHERE PRACTICAL, A DESIRABLE MAXIMUM RATIO OF 1.75:1 SHOULD BE USED.
3. COMPUTE STRAIGHT LINE WIDENING AND SUPERELEVATION TRANSITION FROM MAXIMUM OF FIRST CURVE TO MAXIMUM OF SECOND CURVE.
4. REFER TO CHAPTER 3 OF THE AASHTO GREEN BOOK FOR ADDITIONAL COMPOUND CURVE DESIGN INFORMATION.
5. THE SEPARATE CURVES THAT ARE COMBINED TO CREATE THE COMPOUND CURVE, SHOULD BE OF SUFFICIENT LENGTH TO ALLOW ADEQUATE DEVELOPMENT OF THE FULL SUPERELEVATION ON EACH CURVE.

SPECIFICATION REFERENCE

METHOD OF APPLYING TC-5.11 ON COMPOUND CURVES
RURAL CONDITIONS WITH PAVEMENT WIDENING

VIRGINIA DEPARTMENT OF TRANSPORTATION



ROAD AND BRIDGE STANDARDS

REVISION DATE

SHEET 1 OF 1

803.11

TC-5.11

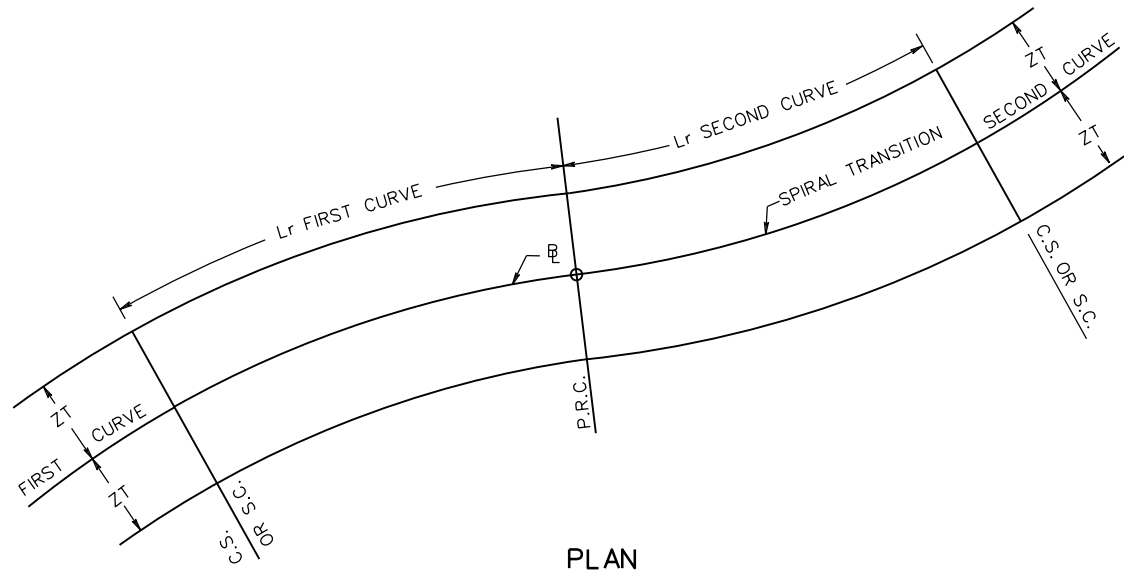

PLAN

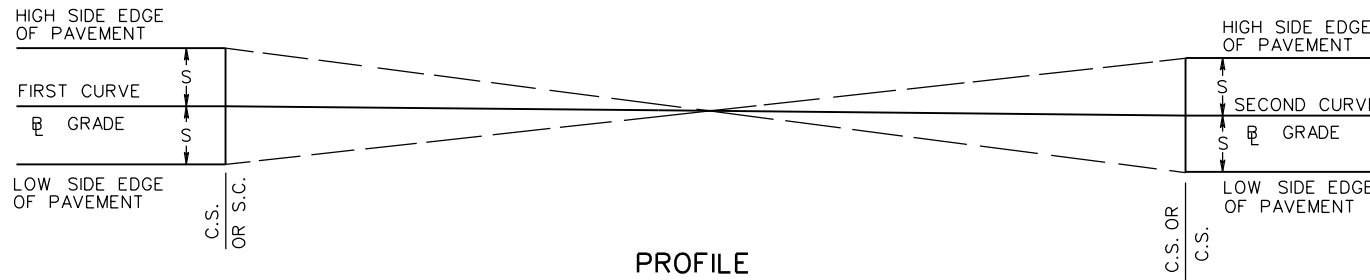

PROFILE

NOTE:

1. COMPUTE STRAIGHT LINE WIDENING AND SUPERELEVATION TRANSITION FROM MAXIMUM OF FIRST CURVE TO MAXIMUM OF SECOND CURVE.
2. REFER TO CHAPTER 3 OF THE AASHTO'S A POLICY ON THE GEOMETRIC DESIGN OF HIGHWAYS AND STREETS FOR ADDITIONAL REVERSE CURVE DESIGN INFORMATION.
3. REVERSE CURVES SHOULD HAVE A CURVE LENGTH THAT ALLOWS ADEQUATE DEVELOPMENT OF THE FULL SUPERELEVATED SECTION OF PAVEMENT FOR EACH CURVE.



ROAD AND BRIDGE STANDARDS

METHOD OF APPLYING TC-5.11 ON REVERSE CURVES RURAL CONDITION WITH PAVEMENT WIDENING

SPECIFICATION
REFERENCE

SHEET 1 OF 1

REVISION DATE

803.12

VIRGINIA DEPARTMENT OF TRANSPORTATION

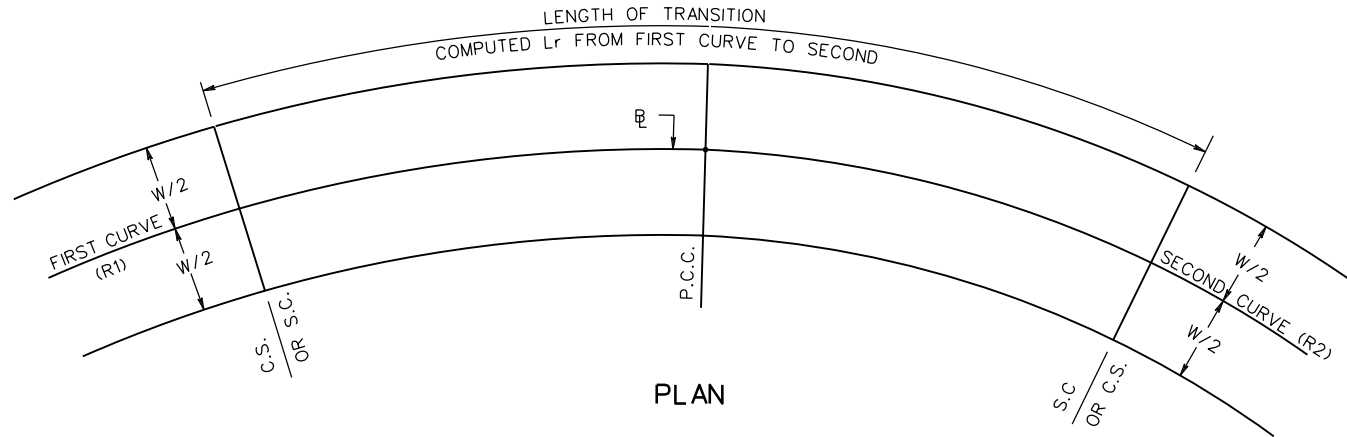

PLAN

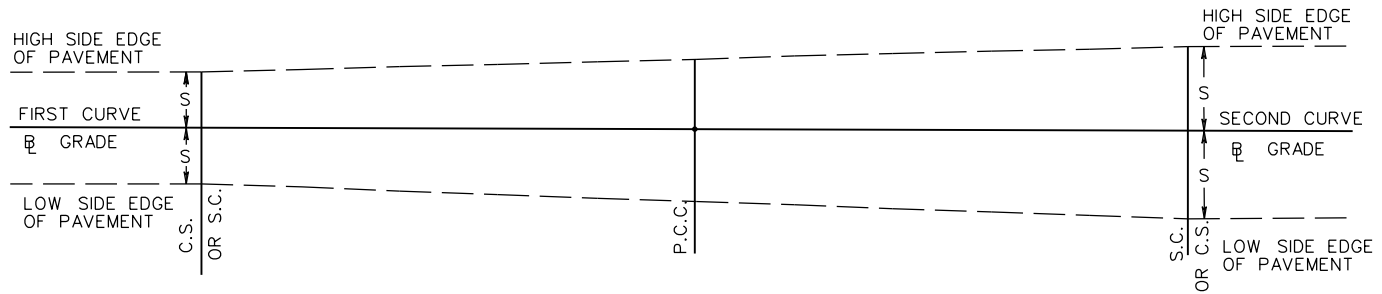

PROFILE

NOTE:

1. FOR COMPOUND CURVES ON OPEN ROADWAYS, THE RATIO OF FLATTER RADIUS (R1) TO THE SHARPER RADIUS (R2) SHALL NOT EXCEED 1.5:1.
2. FOR COMPOUND CURVES ON RAMPS AND AT INTERSECTIONS, THE RATIO OF THE FLATTER RADIUS (R1) TO THE SHARPER RADIUS (R2) SHALL NOT EXCEED 2:1. WHERE PRACTICAL, A DESIRABLE MAXIMUM RATIO OF 1.75:1 SHOULD BE USED.
3. COMPUTE SUPERELEVATION TRANSITION FROM MAXIMUM OF FIRST CURVE TO MAXIMUM OF SECOND CURVE. LENGTH OF COMPOUND SPIRAL COMPUTED PER PAGE 803.20.
4. REFER TO CHAPTER 3 OF THE AASHTO GREEN BOOK FOR ADDITIONAL COMPOUND CURVE DESIGN INFORMATION.
5. THE SEPARATE CURVES THAT ARE COMBINED TO CREATE THE COMPOUND CURVE, SHOULD BE OF SUFFICIENT LENGTH TO ALLOW ADEQUATE DEVELOPMENT OF THE FULL SUPERELEVATION ON EACH CURVE.

SPECIFICATION REFERENCE

METHOD OF APPLYING TC-5.11 ON COMPOUND CURVES
URBAN & RURAL CONDITIONS W/OUT PAVEMENT WIDENING

VIRGINIA DEPARTMENT OF TRANSPORTATION

VDOT

ROAD AND BRIDGE STANDARDS

REVISION DATE

SHEET 1 OF 1

803.13

TC-5.11

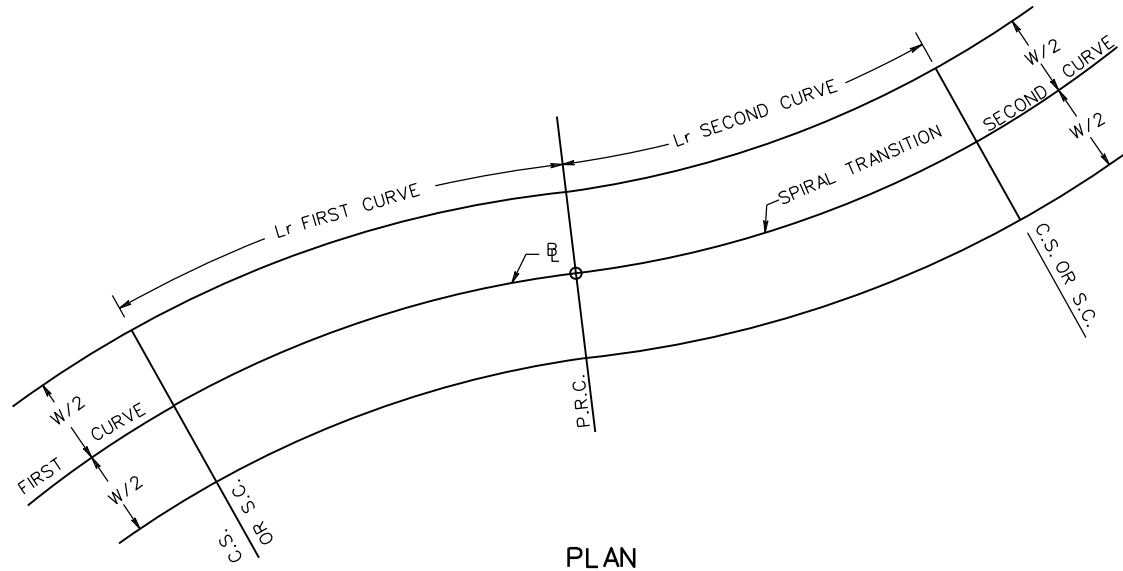

PLAN

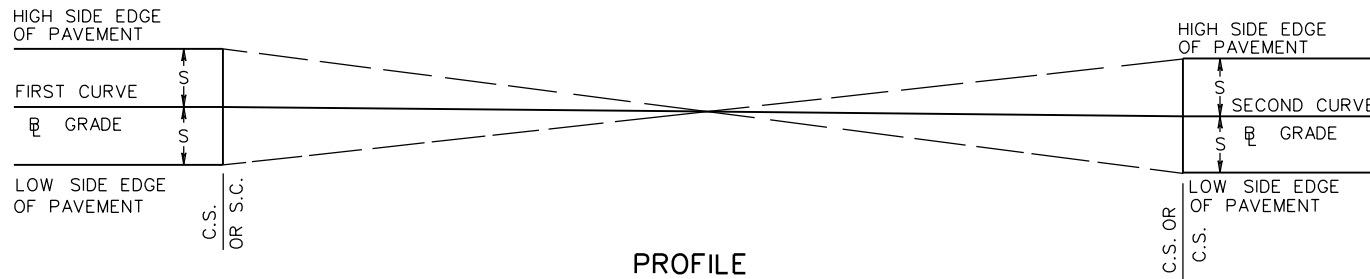

PROFILE

NOTES:

1. COMPUTE SUPERELEVATION TRANSITION FROM MAXIMUM OF FIRST CURVE TO MAXIMUM OF SECOND CURVE. LENGTH OF SUPERELEVATION RUNOFF (L_r) COMPUTED PER PAGE 803.20.
2. REFER TO CHAPTER 3 OF THE AASHTO'S A POLICY ON THE GEOMETRIC DESIGN OF HIGHWAYS AND STREETS FOR ADDITIONAL REVERSE CURVE DESIGN INFORMATION.
3. THE USE OF SPIRAL TRANSITIONS FOR COMPOUND AND REVERSE CURVES ON URBAN ROADWAYS SHOULD BE AVOIDED. HOWEVER, THE ENGINEER DOES HAVE LATITUDE IN THE USE OF SPIRAL TRANSITIONS IF THE GEOMETRICS ARE WARRANTED.
4. REVERSE CURVES SHOULD HAVE A CURVE LENGTH THAT ALLOWS ADEQUATE DEVELOPMENT OF THE FULL SUPERELEVATED SECTION OF PAVEMENT FOR EACH CURVE.



ROAD AND BRIDGE STANDARDS

SHEET 1 OF 1

REVISION DATE

803.14

METHOD OF APPLYING TC-5.11 ON REVERSE CURVES
URBAN & RURAL CONDITIONS W/OUT PAVEMENT WIDENING

VIRGINIA DEPARTMENT OF TRANSPORTATION

SPECIFICATION
REFERENCE

TRANSITION TABLE

LENGTH OF TANGENT RUNOUT (Lt)	START/END OF SUPERELEVATION RUNOFF (Lr)	DISTANCE IN FEET FROM START/END OF SUPERELEVATION RUNOFF SECTION (Lr)				NORMAL CROWN
		1	2	3	4	
220	0	44	88	132	176	220
200	0	40	80	120	140	200
180	0	36	72	108	144	180
160	0	32	64	96	128	160
140	0	28	56	84	112	140
120	0	24	48	72	96	120
100	0	20	40	60	80	100
90	0	18	36	54	72	90
80	0	16	32	48	64	80
60	0	15	30	45	——	60
40	0	20	——	——	——	40

NOTE:

TABLE LISTS POSITIONS ON TRANSITIONS AT WHICH SLOPE STAKES SHOULD BE SET, CONSTRUCTION AND FINAL CROSS-SECTIONS TAKEN, FINE GRADING STAKES (BLUE TOP) SET, AND FORM STAKES SET (CONCRETE PAVEMENT ONLY).

SPECIFICATION REFERENCE	CROWN TRANSITION / TANGENT RUNOUT (Lt) TABLE	ROAD AND BRIDGE STANDARDS
	VIRGINIA DEPARTMENT OF TRANSPORTATION	REVISION DATE SHEET 1 OF 1 803.15

URBAN CONDITIONS RURAL CONDITIONS WITHOUT PAVEMENT WIDENING

FOR USE WITH FLEXIBLE AND CONCRETE PAVEMENT
(Lr POSITIONED 2/3 ±ON TANGENT, 1/3 ±ON CURVE)

LENGTH OF SUPERELEVATION RUNOFF (Lr)	END/ BEGIN TANGENT RUNOUT (Lt)	DISTANCE IN FEET FROM P.C. OR P.T. ON TANGENT						P.C. OR P.T.	DISTANCE IN FEET FROM P.C. OR P.T. ON CURVE			FULL SUPER ELEVATION (E)
		1	2	3	4	5	6		7	8	9	
480	320	272	224	176	128	80	32	STAKE	16	64	112	160
460	307	261	215	169	123	77	31	STAKE	15	61	107	153
440	293	249	205	161	117	73	29	STAKE	15	59	103	147
420	280	238	196	154	112	70	28	STAKE	14	56	98	140
400	267	227	187	147	107	67	27	STAKE	13	53	93	133
380	253	215	177	139	101	63	25	STAKE	13	51	89	127
360	240	204	168	132	96	60	24	STAKE	12	48	84	120
340	227	193	159	125	91	57	23	STAKE	11	45	79	113
320	213	181	149	117	85	53	21	STAKE	11	43	75	107
300	200	170	140	110	80	50	20	STAKE	10	40	70	100
280	187	159	131	103	75	47	19	STAKE	9	37	65	93
260	173	147 *	121	95 *	69	43 *	17	STAKE *	9	35 *	61	87
240	160	136 *	112	88 *	64	40 *	16	STAKE *	8	32 *	56	80
220	147	125 *	103	81 *	59	37 *	15	STAKE *	7	29 *	51	73
200	133	113 *	93	73 *	53	33 *	13	STAKE *	7	27 *	47	67
180	120	102 *	84	66 *	48	30 *	12	STAKE *	6	24 *	42	60
160	107	91 *	75	59 *	43	27 *	11	STAKE *	5	21 *	37	53

NOTE :

TABLE GIVING POSITIONS ON CURVES AT WHICH SLOPE STAKES SHOULD BE SET,
CONSTRUCTION AND FINAL CROSS-SECTIONS TAKEN, FINE GRADING STAKES (BLUE TOP) SET,
AND FORM STAKES SET (CONCRETE PAVEMENT ONLY).

* DENOTES ADDITIONAL STAKING POSITIONS FOR USE WITH CONCRETE PAVEMENT ONLY.

VDOT ROAD AND BRIDGE STANDARDS	<h2 style="margin: 0;">TABLE I</h2> <p style="margin: 0;">VIRGINIA DEPARTMENT OF TRANSPORTATION</p>	SPECIFICATION REFERENCE
SHEET 1 OF 1	REVISION DATE	
803.16		

RURAL CONDITIONS WITH PAVEMENT WIDENING

FOR USE WITH FLEXIBLE AND CONCRETE PAVEMENT

LENGTH OF SUPERELEVATION RUNOFF (Lr)	T.S. OR S.T.	DISTANCE IN FEET FROM T.S. OR S.T. ALONG SPIRAL TRANSITION									S.C. OR C.S.
		1	2	3	4	5	6	7	8	9	
480	0	48	96	144	192	240	288	336	384	432	480
460	0	46	92	138	184	230	276	322	368	414	460
440	0	44	88	132	176	220	264	308	352	396	440
420	0	42	84	126	168	210	252	294	336	378	420
400	0	40	80	120	160	200	240	280	320	360	400
380	0	38	76	114	152	190	228	266	304	342	380
360	0	36	72	108	144	180	216	252	288	324	360
340	0	34	68	102	136	170	204	238	272	306	340
320	0	32	64	96	128	160	192	224	256	288	320
300	0	30	60	90	120	150	180	210	240	270	300
280	0	28	56	84	112	140	168	196	224	252	280
260	0	26 *	52	78 *	104	130 *	156	182 *	208	234 *	260
240	0	24 *	48	72 *	96	120 *	144	168 *	192	216 *	240
220	0	22 *	44	66 *	88	110 *	132	154 *	176	198 *	220
200	0	20 *	40	60 *	80	100 *	120	140 *	160	180 *	200
180	0	18 *	36	54 *	72	90 *	108	126 *	144	162 *	180
160	0	16 *	32	48 *	64	80 *	96	112 *	128	144 *	160

NOTE :

TABLE GIVING POSITIONS ON TRANSITION CURVES AT WHICH SLOPE STAKES SHOULD BE SET, CONSTRUCTION AND FINAL CROSS-SECTIONS TAKEN, FINE GRADING STAKES (BLUE TOP) SET, AND FORM STAKES SET (CONCRETE PAVEMENT ONLY).

* DENOTES ADDITIONAL STAKING POSITIONS FOR USE WITH CONCRETE PAVEMENT ONLY.

SPECIFICATION REFERENCE	<h2>TABLE 2</h2> <p>VIRGINIA DEPARTMENT OF TRANSPORTATION</p>	 ROAD AND BRIDGE STANDARDS	
		REVISION DATE	SHEET 1 OF 1 803.17

TC-5.11

THIS PAGE INTENTIONALLY LEFT BLANK



ROAD AND BRIDGE STANDARDS

SHEET 1 OF 1

REVISION DATE

803.18

SPECIFICATION
REFERENCE

VIRGINIA DEPARTMENT OF TRANSPORTATION

GENERAL DESIGN CONSIDERATIONS

1. WHERE PAVEMENT WIDENING IS REQUIRED, THE APPROPRIATE WIDENING IS ADDED TO THE LANE WIDTH WHEN CALCULATING THE SUPERELEVATION RUNOFF LENGTH (L_r).
2. THE COMPUTED SUPERELEVATION RUNOFF LENGTH (L_r) IS ROUNDED UP TO THE NEAREST FOOT.
3. WHEN THE SUPERELEVATION RUNOFF LENGTH (L_r) IS CALCULATED, IT MUST BE COMPARED WITH THE MINIMUM VALUE LISTED IN THE APPROPRIATE COLUMN ON THE RELATIVE GRADIENT TABLE.
4. TANGENT RUNOUT (L_t) IS ALWAYS ACHIEVED OUTSIDE OF THE SUPERELEVATION RUNOFF SECTION (L_r).
5. NO PAVEMENT WIDENING IS REQUIRED FOR URBAN ROADWAYS.
6. PAVEMENT WIDENING IS APPLIED ONLY WHEN CALCULATED WIDENING (w) IS EQUAL TO OR GREATER THAN 2 FEET. SEE PAGE 803.05 FOR DETAIL.
7. WHEN CALCULATING WIDENING (w) FOR MULTI-LANE RURAL ROADWAYS, WIDENING IS FIRST CALCULATED USING THE SINGLE LANE WIDTH FOR "W".
9. CALCULATED WIDENING IS ROUNDED UP TO THE NEAREST 0.1 FOOT.
10. CURVES WITH SPIRAL CURVE TRANSITIONS MUST HAVE A MINIMUM SUPERELEVATION RUNOFF LENGTH (L_r) EQUAL TO 2 SECONDS OF TRAVEL TIME AT THE ROADWAY'S DESIGN SPEED AS NOTED IN THE RELATIVE GRADIENT TABLE.
11. THE MINIMUM LENGTH OF CURVE SHOULD EQUAL THE LENGTH OF SUPERELEVATION TRANSITION OR L_r . THIS IS TO ALLOW SUFFICIENT DEVELOPMENT OF THE FULL SUPERELEVATED SECTION OF PAVEMENT WHICH SHOULD BE A MINIMUM LENGTH OF $\frac{1}{3}$ THE TRANSITION L_r .
12. REVERSE CURVES SHOULD BE SEPARATED BY A TANGENT OF SUFFICIENT LENGTH TO ALLOW THE FULL L_r AND L_t FOR EACH CURVE. IF THIS IS NOT POSSIBLE A MINIMUM LENGTH OF TANGENT SHOULD ALLOW FOR THE FULL L_r FOR EACH CURVE.
13. REVERSE CURVES THAT MEET AT A PRC SHOULD HAVE A CURVE LENGTH THAT ALLOWS ADEQUATE DEVELOPMENT OF THE FULL SUPERELEVATED SECTION OF PAVEMENT FOR EACH CURVE.
14. THE SEPARATE CURVES THAT ARE COMBINED TO CREATE THE COMPOUND CURVE, SHOULD BE OF SUFFICIENT LENGTH TO ALLOW ADEQUATE DEVELOPMENT OF THE FULL SUPERELEVATION ON EACH CURVE.

MAXIMUM RADIUS FOR USE OF A SPIRAL CURVE TRANSITION

DESIGN SPEED (mph)	MAXIMUM RADIUS (ft)
20	203
25	317
30	456
35	620
40	810
45	1025
50	1265
55	1531
60	1822
65	2138
70	2479
75	2846
80	3238

MAXIMUM LENGTH OF SPIRAL

$$L_{s,max} = \sqrt{24 (p_{max}) R}$$

$L_{s,max}$ = MAXIMUM LENGTH OF SPIRAL, ft

p_{max} = MAXIMUM LATERAL OFFSET BETWEEN THE TANGENT AND CIRCULAR CURVE (3.3 ft)

R = RADIUS OF CIRCULAR CURVE, ft

SPECIFICATION
REFERENCE

METHODOLOGIES FOR CALCULATING TC-5.11 VALUES

VIRGINIA DEPARTMENT OF TRANSPORTATION

VDOT

ROAD AND BRIDGE STANDARDS

REVISION DATE

SHEET 1 OF 1

803.19

RELATIVE GRADIENTS

ADJUSTMENT FACTORS

NUMBER OF LANES ROTATED n_1	ADJUSTMENT FACTOR (b_w)
1	1.00
1.5	0.8333
2	0.75
2.5	0.70
3	0.6667
3.5	0.6425

DESIGN SPEED V_D MPH	MAXIMUM RELATIVE GRADIENT (rg) 12' LANE	MIN. TRANSITION LENGTH IN FEET RURAL CONDITIONS WITH PAVEMENT WIDENING AND REVERSE CURVES FOR ALL CONDITIONS (2 SECOND RULE)	MAXIMUM RELATIVE GRADIENT (rg) RAMPS AND LOOPS		
			16' LANE	18' LANE	24' LANE
			20	0.74	59
25	0.70	74	0.80	0.84	0.93
30	0.66	88	0.75	0.80	0.88
35	0.62	103	0.71	0.75	0.83
40	0.58	117	0.66	0.70	0.77
45	0.54	132	0.61	0.65	0.72
50	0.50	147	0.57	0.60	0.67
55	0.47	161	0.54	0.57	0.63
60	0.45	176	0.51	0.54	0.60
65	0.43	191	0.49	0.52	0.57
70	0.40	205	0.45	0.48	0.53
75	0.38	220	0.43	0.46	0.51
80	0.35	235	0.39	0.42	0.47

DEFINITIONS

- A - FRONT OVERHANG OF DESIGN VEHICLE FROM APPROPRIATE TABLE.
- b_w - ADJUSTMENT FACTOR FROM TABLE.
- C - LATERAL CLEARANCE OF DESIGN VEHICLE FROM APPROPRIATE TABLE.
- E - SUPERELEVATION RATE FROM APPROPRIATE TABLE.
- e_d - DESIGN SUPERELEVATION RATE, PERCENT
- e_{nc} - NORMAL CROSS SLOPE RATE, PERCENT
- F_A - CALCULATED WIDTH OF OVERHANG FOR DESIGN VEHICLE.
- L - WHEELBASE OF DESIGN VEHICLE FROM APPROPRIATE TABLE.
- L_r - LENGTH OF SUPERELEVATION RUNOFF SECTION.
- L_t - LENGTH OF TANGENT RUNOUT SECTION
- M - MULTIPLE LANE FACTOR.
- N - NUMBER OF LANES.
- n_1 - NUMBER OF LANES ROTATED (FROM TABLES).
- P_w - PAVEMENT WIDTH.
- R - RADIUS OF CURVE.
- rg - RELATIVE GRADIENT FROM APPROPRIATE TABLE.
- U - CALCULATED TRACK WIDTH OF DESIGN VEHICLE.
- u - TRACK WIDTH OF DESIGN VEHICLE FROM APPROPRIATE TABLE.
- V_D - DESIGN VELOCITY.
- w - CALCULATED WIDENING.
- W - PAVEMENT WIDTH
- W_c - CALCULATED TOTAL CURVE WIDTH.
- W_n - WIDTH OF LANE.
- Z - CALCULATED EXTRA WIDTH ALLOWANCE.

FORMULAS USED TO CALCULATE SUPERELEVATION RUNOFF (L_r) AND CROWN RUNOUT (L_t)

NO WIDENING REQUIRED

$$L_r = b_w (W_n n_1 E / rg)$$

$$L_r = M(W_n E / rg) \quad (\text{ALT. MULTI-LANE})$$

WIDENING REQUIRED

$$L_r = b_w [E n_1 (W_n + w/N) / rg]$$

$$L_r = MEE(W_n + w/N) / rg \quad (\text{ALT. MULTI-LANE})$$

$$L_t = \left(\frac{e_{nc}}{e_d} \right) L_r$$

FOR SOLVED PROBLEMS USING THIS METHODOLOGY FOR L_r , SEE THE EXAMPLES ON PAGE 803.22

NOTE: AN ALTERNATE METHOD FOR MULTI-LANE ROADWAYS. FOR FOUR LANE UNDIVIDED PAVEMENTS (48') THE L_r IS 1.5 TIMES (M=1.5) THE CORRESPONDING LENGTH FOR TWO LANE HIGHWAYS; AND FOR SIX LANE UNDIVIDED PAVEMENTS (72'), THE L_r IS TWO TIMES (M=2) THE CORRESPONDING LENGTH FOR TWO LANE HIGHWAYS.



ROAD AND BRIDGE STANDARDS

METHODOLOGIES FOR CALCULATING TC-5.11 VALUES

SPECIFICATION REFERENCE

SHEET 1 OF 1

REVISION DATE

803.20

01/14

VIRGINIA DEPARTMENT OF TRANSPORTATION

DESIGN VEHICLE DIMENSIONS

DESIGN VEHICLE TYPE	u WIDTH	A FRONT OVERHANG	L	
			WB *1	WB *2
P	7	3	11	0
SU-30	8	4	20	0
SU-40	8	4	25	0
S-BUS-36	8	2.5	21.3	0
WB-40	8	3	12.5	27.5
WB-62	8.5	4	19.5	4.3

NOTE: THE "L" VALUE USED IN CALCULATING "U" WILL BE THE GREATER OF THE VALUES LISTED UNDER WB*1 OR WB*2 IN THE TABLE. THE "L" VALUE USED IN CALCULATING F_A WILL ALWAYS BE THE VALUE FROM THE WB*1 COLUMN UNDER "L".

LATERAL CLEARANCE

LANE WIDTH	CLEARANCE (C)
9 ft	1.5 ft
10 ft	2 ft
11 ft	2.5 ft
12 ft	3 ft
16 ft	5 ft

FORMULAS USED TO CALCULATE WIDENING (w)

$$U = u + R - \sqrt{R^2 - L^2}$$

$$F_A = \sqrt{R^2 + A(2L + A)} - R$$

$$Z = (V_D / \sqrt{R})$$

$$W_C = N(U + C) + F_A + Z$$

$$w = W_C - 2W_n$$

FOR OTHER DESIGN VEHICLE DIMENSIONS REFER TO THE AASHTO GREEN BOOK.

DESIGN VEHICLE SU-40
24 FT PAVEMENT WIDTH

V_D = 20 MPH R = 200 FT
W_n = 12 FT rg = 0.74
E = 6.1 (6.1% PER 803.32)

$$U = u + R - \sqrt{R^2 - L^2}$$

$$U = 8.0 + 200 - \sqrt{(200)^2 - (25)^2}$$

$$U = 9.56865$$

$$F_A = \sqrt{R^2 + A(2L + A)} - R$$

$$F_A = \sqrt{(200)^2 + 4[2(25) + 4]} - 200$$

$$F_A = .53927$$

$$Z = (V_D / \sqrt{R})$$

$$Z = (20 / \sqrt{200})$$

$$Z = 1.41$$

$$W_C = N(U + C) + F_A + Z$$

$$W_C = 2(9.56865 + 3) + 0.53927 + 1.41$$

$$W_C = 27.08657$$

$$w = W_C - 2W_n = 27.08657 - 2(12) = 3.0865 \text{ or } 3.1$$

DESIGN VEHICLE SU-40
20 FT PAVEMENT WIDTH

V_D = 35 MPH R = 500 FT
W_n = 10 FT rg = 0.62
E = 3.1 (3.1% PER 803.38)

$$U = u + R - \sqrt{R^2 - L^2}$$

$$U = 8.0 + 500 - \sqrt{(500)^2 - (25)^2}$$

$$U = 8.62539$$

$$F_A = \sqrt{R^2 + A(2L + A)} - R$$

$$F_A = \sqrt{(500)^2 + 4[2(25) + 4]} - 500$$

$$F_A = .21595$$

$$Z = (V_D / \sqrt{R})$$

$$Z = (35 / \sqrt{500})$$

$$Z = 1.57$$

$$W_C = N(U + C) + F_A + Z$$

$$W_C = 2(8.62539 + 2) + 0.21595 + 1.57$$

$$W_C = 23.0367$$

$$w = W_C - 2W_n = 23.0367 - 2(10) = 3.0367 \text{ or } 3.0$$

DESIGN VEHICLE WB-62
20 FT PAVEMENT WIDTH

V_D = 50 MPH R = 1000 FT
W_n = 10 FT rg = 0.50
E = 7.6 (7.6% PER 803.38)

$$U = u + R - \sqrt{R^2 - L^2}$$

$$U = 8.5 + 1000 - \sqrt{(1000)^2 - (43)^2}$$

$$U = 9.42492$$

$$F_A = \sqrt{R^2 + A(2L + A)} - R$$

$$F_A = \sqrt{(1000)^2 + 4[2(19.5) + 4]} - 1000$$

$$F_A = .085996$$

$$Z = (V_D / \sqrt{R})$$

$$Z = (50 / \sqrt{1000})$$

$$Z = 1.58$$

$$W_C = N(U + C) + F_A + Z$$

$$W_C = 2(9.42492 + 2) + 0.085996 + 1.58$$

$$W_C = 24.5158$$

$$w = W_C - 2W_n = 24.5158 - 2(10) = 4.5158 \text{ or } 4.5$$

SPECIFICATION REFERENCE

METHODOLOGIES FOR CALCULATING TC-5.11 VALUES



ROAD AND BRIDGE STANDARDS

REVISION DATE

SHEET 1 OF 1

803.21

TC-5.11

RURAL EXAMPLE

20 FT PAVEMENT WIDTH
(DESIGN SOFTWARE - 1 LANE AT 10 FT)

$V_D = 50$ MPH $R = 1000$ FT
 $W_n = 10$ FT $rg = 0.50$
 $E = 7.6$ (7.6% PER 803.38)

$$U = u + R - \sqrt{R^2 - L^2}$$

$$U = 8.5 + 1000 - \sqrt{(1000)^2 - (43)^2}$$

$$U = 9.42492$$

$$F_A = \sqrt{R^2 + A(2L + A)} - R$$

$$F_A = \sqrt{(1000)^2 + 4[2(19.5) + 4]} - 1000$$

$$F_A = .085996$$

$$Z = (V_D / \sqrt{R})$$

$$Z = (50 / \sqrt{1000})$$

$$Z = 1.58$$

$$W_C = N(U + C) + F_A + Z$$

$$W_C = 2(9.42492 + 2) + 0.085996 + 1.58$$

$$W_C = 24.5158$$

$$w = W_C - 2W_n = 24.5158 - 2(10) = 4.5158 \text{ or } 4.5$$

(w>2 THEREFORE WIDENING IS REQUIRED)

$$L_r = [E n_s (W_n + w/2) / rg] b_w$$

$$L_r = [7.6(1)(10 + 4.5/2) / 0.50] 1$$

$$L_r = 7.6 (12.25) / 0.50$$

$$L_r = 186.20$$

RURAL EXAMPLE

72 FT PAVEMENT WIDTH
(DESIGN SOFTWARE - 3 LANES AT 12 FT)

$V_D = 40$ MPH $R = 500$ FT
 $W_n = 12$ FT $rg = 0.58$
 $E = 8.0$ (8% PER PAGE 803.36)

$$U = u + R - \sqrt{R^2 - L^2}$$

$$U = 8.5 + 500 - \sqrt{(500)^2 - (43)^2}$$

$$U = 10.35243$$

$$F_A = \sqrt{R^2 + A(2L + A)} - R$$

$$F_A = \sqrt{(500)^2 + 4[2(19.5) + 4]} - 500$$

$$F_A = .1719$$

$$Z = (V_D / \sqrt{R})$$

$$Z = (40 / \sqrt{500})$$

$$Z = 1.7885$$

$$W_C = 2(U + C) + F_A + Z$$

$$W_C = 2(10.35243 + 3) + 0.1719 + 1.7885$$

$$W_C = 28.6652$$

$$w = W_C - 2W_n = 28.6652 - 2(12) = 4.6652$$

FOR 72' PAVEMENT WIDTH

$$w = 3(4.6652) = 13.9956$$

(w>2 THEREFORE WIDENING IS REQUIRED)

$$L_r = [E n_s (W_n + w/6) / rg] b_w$$

$$L_r = [8 (3) (12 + 13.9956/6) / 0.58] 0.6667$$

$$L_r = (343.9824/0.58) 0.6667$$

$$L_r = 395.4018$$

OR

$$L_r = M[E(W_n + w/N)/rg]$$

$$L_r = 2 [8(12 + 13.9956/6) / 0.58]$$

$$L_r = 2 (114.6608/0.58)$$

$$L_r = 395.3820$$

URBAN EXAMPLES

24 FT PAVEMENT WIDTH
(DESIGN SOFTWARE - 1 LANE AT 12 FT)

$V_D = 40$ MPH $R = 600$ FT
 $W_n = 12$ FT $rg = 0.58$
 $E = 4.0$ (4% PER PAGE 803.28)

$$L_r = (W_n n_s E / rg) b_w$$

$$L_r = [12(1)(4) / 0.58] 1.00$$

$$L_r = (48 / 0.58)$$

$$L_r = 82.7586$$

66 FT PAVEMENT WIDTH
(DESIGN SOFTWARE - 3 LANES AT 11 FT)

$V_D = 40$ MPH $R = 600$ FT
 $W_n = 11$ FT $rg = 0.58$
 $E = 4.0$ (4% PER PAGE 803.28)

$$L_r = b_w (W_n n_s E / rg)$$

$$L_r = 0.6667 [11(3)(4) / 0.58]$$

$$L_r = 0.6667 (132 / 0.58)$$

$$L_r = 151.7317$$

OR

$$L_r = M (E W_n / rg)$$

$$L_r = 2 [4(11) / 0.58]$$

$$L_r = 2 (44 / 0.58)$$

$$L_r = 151.7241$$

VDOT	
ROAD AND BRIDGE STANDARDS	
SHEET 1 OF 1	REVISION DATE
803.22	01/13

CALCULATED TC-5.11 EXAMPLES

VIRGINIA DEPARTMENT OF TRANSPORTATION

SPECIFICATION REFERENCE

MINIMUM RADII AND SUPERELEVATION RUNOFF SECTION LENGTHS (L_r) FOR +2% SUPERELEVATION

RADIUS (FEET)	E (%)	f	DV (MPH)	LENGTH OF SUPERELEVATION RUNOFF (L _r) IN FEET						
				PAVEMENT WIDTH (W)						W > 72'
				24' (1@12')	36' (1.5@12')	48' (2@12')	60' (3@10')	66' (3@11')	72' (3@12')	
> 795	2.0	0.150	45	45	56	67	75	82	90	*
593	2.0	0.160	40	42	52	63	70	77	84	*
408	2.0	0.180	35	39	49	59	65	72	78	*
273	2.0	0.200	30	37	46	55	61	67	74	*
167	2.0	0.230	25	35	43	52	58	64	69	*
92	2.0	0.270	20	33	41	49	55	60	66	*

* FOR PAVEMENT WIDTHS GREATER THAN 72 FEET USE L_r VALUES DEVELOPED BY THE DESIGN SOFTWARE.

MINIMUM RADII FOR DESIGNS
UTILIZING -2% SUPERELEVATION NORMAL PAVEMENT CROWN

RADIUS (FEET)	f	NC (MPH)
> 1039	.150	45
762	.160	40
510	.180	35
333	.200	30
198	.230	25
107	.270	20

SPECIFICATION
REFERENCE

SUMMARY OF STD. TC-5.11 ULS
URBAN-LOW SPEED DESIGN FACTORS

VIRGINIA DEPARTMENT OF TRANSPORTATION



ROAD AND BRIDGE STANDARDS

REVISION DATE SHEET 1 OF 1

803.23

DESIGN FACTORS FOR A DESIGN SPEED OF 20 MPH (URBAN) USING E= 4% MAX.													
RADIUS (FEET)	E (%)	PAVEMENT WIDTH											
		24 FT		36 FT		48 FT		60 FT		66 FT		72 FT	
		DESIGN SOFTWARE EQUIVALENTS (NUMBER OF LANES AT LANE WIDTH)											
		1 @ 12'		1.5 @ 12'		2 @ 12'		3 @ 10'		3 @ 11'		3 @ 12'	
		Lt	Lr	Lt	Lr	Lt	Lr	Lt	Lr	Lt	Lr	Lt	Lr
1410	NC	0	0	0	0	0	0	0	0	0	0	0	0
960	2	33	33	41	41	49	49	55	55	60	60	65	65
868	2.1	33	35	41	43	49	52	55	57	60	63	65	69
756	2.2	33	36	41	45	49	54	55	60	60	66	65	72
684	2.3	33	38	41	47	49	56	55	63	60	69	65	75
565	2.4	33	39	41	49	49	59	55	65	60	72	65	78
504	2.5	33	41	41	51	49	61	55	68	60	75	65	82
408	2.6	33	43	41	53	49	64	55	71	60	78	65	85
376	2.7	33	44	41	55	49	66	55	73	60	81	65	88
348	2.8	33	46	41	57	49	69	55	76	60	84	65	91
300	2.9	33	48	41	59	49	71	55	79	60	87	65	95
264	3	33	49	41	61	49	73	55	82	60	90	65	98
254	3.1	33	51	41	63	49	76	55	84	60	93	65	101
229	3.2	33	52	41	65	49	78	55	87	60	96	65	104
197	3.3	33	54	41	67	49	81	55	90	60	99	65	108
188	3.4	33	56	41	69	49	83	55	92	60	102	65	111
167	3.5	33	57	41	71	49	86	55	95	60	105	65	114
156	3.6	33	59	41	73	49	88	55	98	60	108	65	117
147	3.7	33	60	41	75	49	90	55	100	60	110	65	120
124	3.8	33	62	41	77	49	93	55	103	60	113	65	124
116	3.9	33	64	41	79	49	95	55	106	60	116	65	127
87	4	33	65	41	81	49	98	55	109	60	119	65	130

NOTE:

Lt AND Lr VALUES IN FEET.

FOR PAVEMENT WIDTHS GREATER THAN 72 FEET USE Lr VALUES DEVELOPED BY THE DESIGN SOFTWARE.

LISTED RADIUS IS THE MINIMUM ALLOWABLE RADIUS FOR THE CORRESPONDING E, Lt, AND Lr VALUES.



ROAD AND BRIDGE STANDARDS

SHEET 1 OF 1

REVISION DATE

803.24

TRANSITION CURVES - URBAN 20 MPH DESIGN SPEED

VIRGINIA DEPARTMENT OF TRANSPORTATION

SPECIFICATION
REFERENCE

DESIGN FACTORS FOR A DESIGN SPEED OF 25 MPH (URBAN) USING E= 4% MAX.													
RADIUS (FEET)	E (%)	PAVEMENT WIDTH											
		24 FT		36 FT		48 FT		60 FT		66 FT		72 FT	
		DESIGN SOFTWARE EQUIVALENTS (NUMBER OF LANES AT LANE WIDTH)											
		1 @ 12'		1.5 @ 12'		2 @ 12'		3 @ 10'		3 @ 11'		3 @ 12'	
		Lt	Lr	Lt	Lr	Lt	Lr	Lt	Lr	Lt	Lr	Lt	Lr
2050	NC	0	0	0	0	0	0	0	0	0	0	0	0
1350	2	35	35	43	43	52	52	58	58	63	63	69	69
1234	2.1	35	36	43	45	52	54	58	60	63	66	69	72
1119	2.2	35	38	43	48	52	57	58	63	63	70	69	76
994	2.3	35	40	43	50	52	60	58	66	63	73	69	79
858	2.4	35	42	43	52	52	62	58	69	63	76	69	83
750	2.5	35	43	43	54	52	65	58	72	63	79	69	86
664	2.6	35	45	43	56	52	67	58	75	63	82	69	90
593	2.7	35	47	43	58	52	70	58	78	63	85	69	93
534	2.8	35	48	43	60	52	72	58	80	63	88	69	96
483	2.9	35	50	43	63	52	75	58	83	63	92	69	100
440	3	35	52	43	65	52	78	58	86	63	95	69	103
402	3.1	35	54	43	67	52	80	58	89	63	98	69	107
369	3.2	35	55	43	69	52	83	58	92	63	101	69	110
339	3.3	35	57	43	71	52	85	58	95	63	104	69	114
311	3.4	35	59	43	73	52	88	58	98	63	107	69	117
286	3.5	35	60	43	75	52	90	58	100	63	110	69	120
263	3.6	35	62	43	78	52	93	58	103	63	114	69	124
241	3.7	35	64	43	80	52	96	58	106	63	117	69	127
218	3.8	35	66	43	82	52	98	58	109	63	120	69	131
195	3.9	35	67	43	84	52	101	58	112	63	123	69	134
155	4	35	69	43	86	52	103	58	115	63	126	69	138

NOTE:

Lt AND Lr VALUES IN FEET.

FOR PAVEMENT WIDTHS GREATER THAN 72 FEET USE Lr VALUES DEVELOPED BY THE DESIGN SOFTWARE.

LISTED RADIUS IS THE MINIMUM ALLOWABLE RADIUS FOR THE CORRESPONDING E, Lt, AND Lr VALUES.

SPECIFICATION REFERENCE

TRANSITION CURVES - URBAN 25 MPH DESIGN SPEED

VIRGINIA DEPARTMENT OF TRANSPORTATION



ROAD AND BRIDGE STANDARDS

REVISION DATE SHEET 1 OF 1

803.25

DESIGN FACTORS FOR A DESIGN SPEED OF 30 MPH (URBAN) USING E= 4% MAX.													
RADIUS (FEET)	E (%)	PAVEMENT WIDTH											
		24 FT		36 FT		48 FT		60 FT		66 FT		72 FT	
		DESIGN SOFTWARE EQUIVALENTS (NUMBER OF LANES AT LANE WIDTH)											
		1 @ 12'		1.5 @ 12'		2 @ 12'		3 @ 10'		3 @ 11'		3 @ 12'	
		Lt	Lr	Lt	Lr	Lt	Lr	Lt	Lr	Lt	Lr	Lt	Lr
2830	NC	0	0	0	0	0	0	0	0	0	0	0	0
1885	2.0	37	37	46	46	55	55	61	61	67	67	73	73
1734	2.1	37	39	46	48	55	58	61	64	67	70	73	77
1588	2.2	37	40	46	50	55	60	61	67	67	74	73	80
1442	2.3	37	42	46	53	55	63	61	70	67	77	73	84
1282	2.4	37	44	46	55	55	66	61	73	67	80	73	88
1134	2.5	37	46	46	57	55	69	61	76	67	84	73	91
1013	2.6	37	48	46	60	55	71	61	79	67	87	73	95
913	2.7	37	50	46	62	55	74	61	82	67	90	73	99
827	2.8	37	51	46	64	55	77	61	85	67	94	73	102
754	2.9	37	53	46	66	55	80	61	88	67	97	73	106
689	3.0	37	55	46	69	55	82	61	91	67	100	73	110
633	3.1	37	57	46	71	55	85	61	94	67	104	73	113
582	3.2	37	59	46	73	55	88	61	97	67	107	73	117
536	3.3	37	60	46	75	55	90	61	100	67	110	73	120
495	3.4	37	62	46	78	55	93	61	104	67	114	73	124
456	3.5	37	64	46	80	55	96	61	107	67	117	73	128
420	3.6	37	66	46	82	55	99	61	110	67	120	73	131
385	3.7	37	68	46	85	55	101	61	113	67	124	73	135
351	3.8	37	70	46	87	55	104	61	116	67	127	73	139
314	3.9	37	71	46	89	55	107	61	119	67	130	73	142
251	4.0	37	73	46	91	55	110	61	122	67	134	73	146

NOTE:

Lt AND Lr VALUES IN FEET.

FOR PAVEMENT WIDTHS GREATER THAN 72 FEET USE Lr VALUES DEVELOPED BY THE DESIGN SOFTWARE.

LISTED RADIUS IS THE MINIMUM ALLOWABLE RADIUS FOR THE CORRESPONDING E, Lt, AND Lr VALUES.



ROAD AND BRIDGE STANDARDS

SHEET 1 OF 1

REVISION DATE

803.26

TRANSITION CURVES - URBAN 30 MPH DESIGN SPEED

VIRGINIA DEPARTMENT OF TRANSPORTATION

SPECIFICATION
REFERENCE

**DESIGN FACTORS FOR A DESIGN SPEED OF 35 MPH
(URBAN) USING E= 4% MAX.**

RADIUS (FEET)	E (%)	PAVEMENT WIDTH												
		24 FT		36 FT		48 FT		60 FT		66 FT		72 FT		
		DESIGN SOFTWARE EQUIVALENTS (NUMBER OF LANES AT LANE WIDTH)												
		1 @ 12'		1.5 @ 12'		2 @ 12'		3 @ 10'		3 @ 11'		3 @ 12'		
Lt	Lr	Lt	Lr	Lt	Lr	Lt	Lr	Lt	Lr	Lt	Lr	CR	Lr	
3730	NC	0	0	0	0	0	0	0	0	0	0	0	0	0
2511	2.0	39	39	49	49	59	59	65	65	71	71	78	78	
2320	2.1	39	41	49	51	59	61	65	68	71	75	78	82	
2138	2.2	39	43	49	54	59	64	65	71	71	79	78	86	
1961	2.3	39	45	49	56	59	67	65	75	71	82	78	90	
1781	2.4	39	47	49	59	59	70	65	78	71	86	78	93	
1593	2.5	39	49	49	61	59	73	65	81	71	89	78	97	
1434	2.6	39	51	49	63	59	76	65	84	71	93	78	101	
1299	2.7	39	53	49	66	59	79	65	88	71	96	78	105	
1184	2.8	39	55	49	68	59	82	65	91	71	100	78	109	
1084	2.9	39	57	49	71	59	85	65	94	71	103	78	113	
995	3.0	39	59	49	73	59	88	65	97	71	107	78	117	
916	3.1	39	60	49	75	59	90	65	100	71	110	78	120	
846	3.2	39	62	49	78	59	93	65	104	71	114	78	124	
782	3.3	39	64	49	80	59	96	65	107	71	118	78	128	
723	3.4	39	66	49	83	59	99	65	110	71	121	78	132	
668	3.5	39	68	49	85	59	102	65	113	71	125	78	136	
617	3.6	39	70	49	88	59	105	65	117	71	128	78	140	
567	3.7	39	72	49	90	59	108	65	120	71	132	78	144	
518	3.8	39	74	49	92	59	111	65	123	71	135	78	148	
465	3.9	39	76	49	95	59	114	65	126	71	139	78	151	
373	4.0	39	78	49	97	59	117	65	130	71	142	78	155	

NOTE:

Lt AND Lr VALUES IN FEET.

FOR PAVEMENT WIDTHS GREATER THAN 72 FEET USE Lr VALUES DEVELOPED BY THE DESIGN SOFTWARE.

LISTED RADIUS IS THE MINIMUM ALLOWABLE RADIUS FOR THE CORRESPONDING E, Lt, AND Lr VALUES.

SPECIFICATION REFERENCE

**TRANSITION CURVES - URBAN
35 MPH DESIGN SPEED**

VIRGINIA DEPARTMENT OF TRANSPORTATION



ROAD AND BRIDGE STANDARDS

REVISION DATE

SHEET 1 OF 1

803.27

DESIGN FACTORS FOR A DESIGN SPEED OF 40 MPH (URBAN) USING E= 4% MAX.													
RADIUS (FEET)	E (%)	PAVEMENT WIDTH											
		24 FT		36 FT		48 FT		60 FT		66 FT		72 FT	
		DESIGN SOFTWARE EQUIVALENTS (NUMBER OF LANES AT LANE WIDTH)											
		1 @ 12'		1.5 @ 12'		2 @ 12'		3 @ 10'		3 @ 11'		3 @ 12'	
		Lt	Lr	Lt	Lr	Lt	Lr	Lt	Lr	Lt	Lr	Lt	Lr
4770	NC	0	0	0	0	0	0	0	0	0	0	0	0
3245	2.0	42	42	52	52	63	63	69	69	76	76	83	83
3009	2.1	42	44	52	55	63	66	69	73	76	80	83	87
2787	2.2	42	46	52	57	63	69	69	76	76	84	83	92
2575	2.3	42	48	52	60	63	72	69	80	76	88	83	96
2367	2.4	42	50	52	63	63	75	69	83	76	92	83	100
2155	2.5	42	52	52	65	63	78	69	87	76	95	83	104
1954	2.6	42	54	52	68	63	81	69	90	76	99	83	108
1782	2.7	42	56	52	70	63	84	69	94	76	103	83	112
1633	2.8	42	58	52	73	63	87	69	97	76	107	83	116
1502	2.9	42	60	52	75	63	90	69	100	76	110	83	120
1385	3.0	42	63	52	78	63	94	69	104	76	114	83	125
1281	3.1	42	65	52	81	63	97	69	107	76	118	83	129
1187	3.2	42	67	52	83	63	100	69	111	76	122	83	133
1100	3.3	42	69	52	86	63	103	69	114	76	126	83	137
1020	3.4	42	71	52	88	63	106	69	118	76	129	83	141
946	3.5	42	73	52	91	63	109	69	121	76	133	83	145
875	3.6	42	75	52	94	63	112	69	125	76	137	83	149
806	3.7	42	77	52	96	63	115	69	128	76	141	83	154
738	3.8	42	79	52	99	63	118	69	132	76	145	83	158
664	3.9	42	81	52	101	63	122	69	135	76	148	83	162
536	4.0	42	83	52	104	63	125	69	138	76	152	83	166

NOTE:

Lt AND Lr VALUES IN FEET.

FOR PAVEMENT WIDTHS GREATER THAN 72 FEET USE Lr VALUES DEVELOPED BY THE DESIGN SOFTWARE.

LISTED RADIUS IS THE MINIMUM ALLOWABLE RADIUS FOR THE CORRESPONDING E, Lt, AND Lr VALUES.



ROAD AND BRIDGE STANDARDS

TRANSITION CURVES - URBAN
40 MPH DESIGN SPEED

VIRGINIA DEPARTMENT OF TRANSPORTATION

SPECIFICATION REFERENCE

SHEET 1 OF 1

REVISION DATE

803.28

DESIGN FACTORS FOR A DESIGN SPEED OF 45 MPH
(URBAN) USING E= 4% MAX.

RADIUS (FEET)	E (%)	PAVEMENT WIDTH											
		24 FT		36 FT		48 FT		60 FT		66 FT		72 FT	
		DESIGN SOFTWARE EQUIVALENTS (NUMBER OF LANES AT LANE WIDTH)											
		1 @ 12'		1.5 @ 12'		2 @ 12'		3 @ 10'		3 @ 11'		3 @ 12'	
Lt	Lr	Lt	Lr	Lt	Lr	Lt	Lr	Lt	Lr	Lt	Lr		
5930	NC	0	0	0	0	0	0	0	0	0	0	0	
4058	2.0	45	45	56	56	67	67	75	75	82	82	89	89
3771	2.1	45	47	56	59	67	70	75	78	82	86	89	94
3502	2.2	45	49	56	62	67	74	75	82	82	90	89	98
3248	2.3	45	52	56	64	67	77	75	86	82	94	89	103
3002	2.4	45	54	56	67	67	80	75	89	82	98	89	107
2758	2.5	45	56	56	70	67	84	75	93	82	102	89	112
2516	2.6	45	58	56	73	67	87	75	97	82	106	89	116
2304	2.7	45	60	56	75	67	90	75	100	82	110	89	120
2119	2.8	45	63	56	78	67	94	75	104	82	115	89	125
1955	2.9	45	65	56	81	67	97	75	108	82	119	89	129
1808	3.0	45	67	56	84	67	100	75	112	82	123	89	134
1676	3.1	45	69	56	87	67	104	75	115	82	127	89	138
1556	3.2	45	72	56	89	67	107	75	119	82	131	89	143
1446	3.3	45	74	56	92	67	110	75	123	82	135	89	147
1343	3.4	45	76	56	95	67	114	75	126	82	139	89	152
1247	3.5	45	78	56	98	67	117	75	130	82	143	89	156
1156	3.6	45	80	56	100	67	120	75	134	82	147	89	160
1067	3.7	45	83	56	103	67	124	75	138	82	151	89	165
978	3.8	45	85	56	106	67	127	75	141	82	155	89	169
883	3.9	45	87	56	109	67	130	75	145	82	159	89	174
713	4.0	45	89	56	112	67	134	75	149	82	163	89	178

NOTE:

Lt AND Lr VALUES IN FEET.

FOR PAVEMENT WIDTHS GREATER THAN 72 FEET USE Lr VALUES DEVELOPED BY THE DESIGN SOFTWARE.

LISTED RADIUS IS THE MINIMUM ALLOWABLE RADIUS FOR THE CORRESPONDING E, Lt, AND Lr VALUES.

SPECIFICATION REFERENCE

TRANSITION CURVES - URBAN
45 MPH DESIGN SPEED

VIRGINIA DEPARTMENT OF TRANSPORTATION



ROAD AND BRIDGE STANDARDS

REVISION DATE

SHEET 1 OF 1

803.29

DESIGN FACTORS FOR A DESIGN SPEED OF 50 MPH
(URBAN) USING E= 4 % MAX.

RADIUS (FEET)	E (%)	PAVEMENT WIDTH											
		24 FT		36 FT		48 FT		60 FT		66 FT		72 FT	
		DESIGN SOFTWARE EQUIVALENTS (NUMBER OF LANES AT LANE WIDTH)											
		1 @ 12'		1.5 @ 12'		2 @ 12'		3 @ 10'		3 @ 11'		3 @ 12'	
Lt	Lr	Lt	Lr	Lt	Lr	Lt	Lr	Lt	Lr	Lt	Lr	Lt	Lr
7220	NC	0	0	0	0	0	0	0	0	0	0	0	0
4972	2.0	48	48	60	60	72	72	80	80	88	88	96	96
4629	2.1	48	51	60	63	72	76	80	84	88	93	96	101
4310	2.2	48	53	60	66	72	80	80	88	88	97	96	106
4010	2.3	48	56	60	69	72	83	80	92	88	102	96	111
3723	2.4	48	58	60	72	72	87	80	96	88	106	96	116
3444	2.5	48	60	60	75	72	90	80	100	88	110	96	120
3166	2.6	48	63	60	78	72	94	80	104	88	115	96	125
2911	2.7	48	65	60	81	72	98	80	108	88	119	96	130
2686	2.8	48	68	60	84	72	101	80	112	88	124	96	135
2486	2.9	48	70	60	87	72	105	80	116	88	128	96	140
2306	3.0	48	72	60	90	72	108	80	120	88	132	96	144
2143	3.1	48	75	60	93	72	112	80	124	88	137	96	149
1994	3.2	48	77	60	96	72	116	80	128	88	141	96	154
1857	3.3	48	80	60	99	72	119	80	132	88	146	96	159
1729	3.4	48	82	60	102	72	123	80	136	88	150	96	164
1608	3.5	48	84	60	105	72	126	80	140	88	154	96	168
1493	3.6	48	87	60	108	72	130	80	144	88	159	96	173
1381	3.7	48	89	60	111	72	134	80	148	88	163	96	178
1268	3.8	48	92	60	114	72	137	80	152	88	168	96	183
1146	3.9	48	94	60	117	72	141	80	156	88	172	96	188
929	4.0	48	96	60	120	72	144	80	160	88	176	96	192

NOTE:

Lt AND Lr VALUES IN FEET.

FOR PAVEMENT WIDTHS GREATER THAN 72 FEET USE Lr VALUES DEVELOPED BY THE DESIGN SOFTWARE.

LISTED RADIUS IS THE MINIMUM ALLOWABLE RADIUS FOR THE CORRESPONDING E, Lt AND Lr VALUES.



ROAD AND BRIDGE STANDARDS

SHEET 1 OF 1

REVISION DATE

803.30

TRANSITION CURVES - URBAN
50 MPH DESIGN SPEED

VIRGINIA DEPARTMENT OF TRANSPORTATION

SPECIFICATION
REFERENCE

DESIGN FACTORS FOR A DESIGN SPEED OF 55 MPH (URBAN) USING E= 4% MAX.													
RADIUS (FEET)	E (%)	PAVEMENT WIDTH											
		24 FT		36 FT		48 FT		60 FT		66 FT		72 FT	
		DESIGN SOFTWARE EQUIVALENTS (NUMBER OF LANES AT LANE WIDTH)											
		1 @ 12'		1.5 @ 12'		2 @ 12'		3 @ 10'		3 @ 11'		3 @ 12'	
		Lt	Lr	Lt	Lr	Lt	Lr	Lt	Lr	Lt	Lr	Lt	Lr
8650	NC	0	0	0	0	0	0	0	0	0	0	0	0
5995	2.0	52	52	64	64	77	77	86	86	94	94	103	103
5592	2.1	52	54	64	68	77	81	86	90	94	99	103	108
5218	2.2	52	57	64	71	77	85	86	94	94	103	103	113
4869	2.3	52	59	64	74	77	89	86	98	94	108	103	118
4538	2.4	52	62	64	77	77	92	86	103	94	113	103	123
4220	2.5	52	64	64	80	77	96	86	107	94	118	103	128
3909	2.6	52	67	64	83	77	100	86	111	94	122	103	133
3610	2.7	52	69	64	87	77	104	86	115	94	127	103	138
3343	2.8	52	72	64	90	77	108	86	120	94	132	103	143
3104	2.9	52	75	64	93	77	112	86	124	94	136	103	149
2888	3.0	52	77	64	96	77	115	86	128	94	141	103	154
2691	3.1	52	80	64	99	77	119	86	132	94	146	103	159
2510	3.2	52	82	64	103	77	123	86	137	94	150	103	164
2343	3.3	52	85	64	106	77	127	86	141	94	155	103	169
2186	3.4	52	87	64	109	77	131	86	145	94	160	103	174
2037	3.5	52	90	64	112	77	135	86	149	94	164	103	179
1895	3.6	52	92	64	115	77	138	86	154	94	169	103	184
1756	3.7	52	95	64	119	77	142	86	158	94	174	103	189
1615	3.8	52	98	64	122	77	146	86	162	94	178	103	195
1462	3.9	52	100	64	125	77	150	86	166	94	183	103	200
1191	4.0	52	103	64	128	77	154	86	171	94	188	103	205

NOTE:

Lt AND Lr VALUES IN FEET.

FOR PAVEMENT WIDTHS GREATER THAN 72 FEET USE Lr VALUES DEVELOPED BY THE DESIGN SOFTWARE.

LISTED RADIUS IS THE MINIMUM ALLOWABLE RADIUS FOR THE CORRESPONDING E, Lt, AND Lr VALUES.

SPECIFICATION REFERENCE

TRANSITION CURVES - URBAN 55 MPH DESIGN SPEED

VIRGINIA DEPARTMENT OF TRANSPORTATION



ROAD AND BRIDGE STANDARDS

REVISION DATE	SHEET 1 OF 1
---------------	--------------

803.31

DESIGN FACTORS FOR A DESIGN SPEED OF 20 MPH (RURAL) USING E= 8% MAX.

TC-5.11

DESIGN VELOCITY +20		DESIGN SOFTWARE EQUIVALENTS (NUMBER OF LANES AT LANE WIDTH)																		INTERCHANGE RAMPS					
		WIDTH+ 18 FT				WIDTH+20 FT				WIDTH+22 FT				WIDTH+24 FT				WIDTH+48 FT				16 FT		18 FT	
		1 @ 9'		1 @ 10'		1 @ 10'		1 @ 11'		1 @ 12'		1 @ 12'		2 @ 12'		Lr		Lr		Lr		Lr			
		Lt	w	Lt	w	Lt	w	Lt	w	Lt	w	Lt	w	Lt	w	Lt	Lr	Lt	Lr	Lt	Lr	Lt	Lr		
1640	NC	0	0	0	0	0	0	0	0	0	0	0	0	0	0	0	0	0	0	0	0	0			
1210	2	28	28	2.2	28	28	0	30	30	0	33	33	0	49	49	0	39	39	0	39	39	41	41		
1180	2.1	28	29	2.3	28	29	0	30	32	0	33	35	0	49	52	0	39	40	0	39	40	41	43		
1100	2.2	29	31	2.3	28	30	0	30	33	0	33	36	0	49	54	0	39	42	0	39	42	41	45		
1020	2.3	28	32	2.4	28	32	0	30	35	0	33	38	0	49	56	0	39	44	0	39	44	41	47		
1008	2.4	29	34	2.4	28	33	0	30	36	0	33	39	0	49	59	0	39	46	0	39	46	41	49		
960	2.5	28	35	2.5	28	34	0	30	38	0	33	41	0	49	61	0	39	48	0	39	48	41	51		
880	2.6	29	37	2.6	28	36	0	30	39	0	33	43	0	49	64	0	39	50	0	39	50	41	53		
840	2.7	29	38	2.6	28	37	0	30	41	0	33	44	0	49	66	0	39	52	0	39	52	41	55		
810	2.8	29	40	2.7	28	38	0	30	42	0	33	46	0	49	69	0	39	54	0	39	54	41	57		
774	2.9	29	41	2.7	28	40	0	30	44	0	33	48	0	49	71	0	39	56	0	39	56	41	59		
720	3	28	42	2.7	28	41	0	30	45	0	33	49	0	49	73	0	39	58	0	39	58	41	61		
760	3.1	29	44	2.8	28	42	0	30	47	0	33	51	0	49	76	0	39	60	0	39	60	41	63		
680	3.2	29	46	2.9	28	44	0	30	48	0	33	52	0	49	78	0	39	61	0	39	61	41	65		
658	3.3	29	47	2.9	28	45	0	30	50	0	33	54	0	49	81	0	39	63	0	39	63	41	67		
641	3.4	29	49	3	30	51	2	30	51	0	33	56	0	49	83	0	39	65	0	39	65	41	69		
617	3.5	29	50	3	30	53	2	30	53	0	33	57	0	49	86	0	39	67	0	39	67	41	71		
595	3.6	29	52	3.1	30	54	2.1	30	54	0	33	59	0	49	88	0	39	69	0	39	69	41	73		
574	3.7	29	53	3.2	30	56	2.2	30	55	0	33	60	0	49	90	0	39	71	0	39	71	41	75		
548	3.8	29	55	3.2	30	57	2.2	30	57	0	33	62	0	49	93	0	39	73	0	39	73	41	77		
528	3.9	30	57	3.3	31	59	2.3	30	58	0	33	64	0	49	95	0	39	75	0	39	75	41	79		
499	4	29	58	3.4	31	61	2.4	30	60	0	33	65	0	49	98	0	39	77	0	39	77	41	81		
484	4.1	30	60	3.5	31	63	2.5	30	61	0	33	67	0	49	100	0	39	79	0	39	79	41	83		
468	4.2	30	62	3.5	31	64	2.5	30	63	0	33	69	0	49	103	0	39	80	0	39	80	41	85		
451	4.3	30	63	3.6	31	66	2.6	30	64	0	33	70	0	49	105	0	39	82	0	39	82	41	87		
435	4.4	30	65	3.7	31	68	2.7	30	66	0	33	72	0	49	108	0	39	84	0	39	84	41	89		
418	4.5	30	67	3.8	32	70	2.8	30	67	0	33	73	0	49	110	0	39	86	0	39	86	41	92		
402	4.6	30	69	3.9	31	71	2.9	30	69	0	33	75	0	49	112	0	39	88	0	39	88	41	94		
373	4.7	31	71	4.1	32	74	3.1	33	77	0	33	77	0	49	115	0	39	90	0	39	90	41	96		
366	4.8	30	72	4.1	32	75	3.1	33	79	2.1	33	78	0	49	117	0	39	92	0	39	92	41	98		
342	4.9	31	74	4.3	32	78	3.3	33	83	2.3	33	80	0	49	120	0	39	94	0	39	94	41	100		
330	5	31	76	4.4	32	80	3.4	33	83	2.4	33	82	0	49	122	0	39	96	0	39	96	41	102		
309	5.1	31	78	4.6	33	82	3.6	34	85	2.6	33	83	0	49	125	0	39	98	0	39	98	41	104		
298	5.2	31	80	4.7	33	84	3.7	34	87	2.7	33	85	0	49	127	0	39	100	0	39	100	41	106		
276	5.3	32	83	4.9	33	86	3.9	34	90	2.9	33	86	0	49	129	0	39	101	0	39	101	41	108		
268	5.4	32	84	5	33	88	4	34	92	3	36	95	2	53	143	4	39	103	0	39	103	41	110		
252	5.5	32	87	5.2	33	90	4.2	35	94	3.2	36	98	2.2	54	147	4.4	39	105	0	39	105	41	112		
244	5.6	32	89	5.4	34	93	4.4	35	97	3.4	36	100	2.4	54	150	4.8	39	107	0	39	107	41	114		
235	5.7	32	91	5.5	34	95	4.5	35	99	3.5	36	103	2.5	55	154	5	39	109	0	39	109	41	116		
226	5.8	33	93	5.6	34	97	4.6	35	101	3.6	36	105	2.6	55	157	5.2	39	111	0	39	111	41	118		
214	5.9	33	96	5.9	34	100	4.9	36	104	3.9	37	108	2.9	55	161	5.8	39	113	0	39	113	41	120		
204	6	33	98	6.1	34	102	5.1	36	106	4.1	37	110	3.1	55	165	6.2	39	115	0	39	115	41	122		
199	6.1	33	100	6.2	35	104	5.2	36	108	4.2	37	113	3.2	56	169	6.4	39	117	0	39	117	41	124		
192	6.2	33	102	6.3	35	106	5.3	36	111	4.3	37	115	3.3	56	172	6.6	39	119	0	39	119	41	126		
181	6.3	34	105	6.6	35	109	5.6	37	114	4.6	38	118	3.6	57	177	7.2	39	120	0	39	120	41	128		
174	6.4	34	108	6.8	35	112	5.8	37	116	4.8	38	121	3.8	57	181	7.6	39	122	0	39	122	41	130		
167	6.5	34	110	7	36	115	6	37	119	5	38	123	4	57	185	8	39	124	0	39	124	41	132		
160	6.6	35	113	7.2	36	117	6.2	37	122	5.2	39	126	4.2	58	189	8.4	39	126	0	39	126	41	134		
156	6.7	35	115	7.4	36	120	6.4	38	125	5.4	39	129	4.4	58	193	8.8	39	128	0	39	128	41	136		
149	6.8	35	118	7.6	37	123	6.6	38	127	5.6	39	132	4.6	59	198	9.2	39	130	0	39	130	41	138		
145	6.9	36	121	7.8	37	125	6.8	38	130	5.8	40	135	4.8	59	202	9.6	39	132	0	39	132	41	140		
140	7	36	123	8	37	128	7	38	133	6	40	138	5	59	206	10	39	134	0	39	134	41	142		
134	7.1	36	127	8.3	37	131	7.3	39	136	6.3	40	141	5.3	60	211	10.6	39	136	0	39	136	41	144		
128	7.2	37	130	8.6	38	135	7.6	39	140	6.6	40	144	5.6	60	216	11.2	39	138	0	39	138	41	146		
124	7.3	37	133	8.8	38	138	7.8	40	143	6.8	41	147	5.8	61	221	11.6	39	140	0	39	140	41	148		
120	7.4	37	135	9	38	140	8	40	145	7	41	150	6	61	225	12	39	141	0	39	141	41	150		
114	7.5	38	140	9.5	39	145	8.5	40	150	7.5	42	155	6.5	62	232	13	39	143	0	39	143	41	152		
107	7.6	38	144	9.9	40	149	8.9	41	154	7.9	42	159	6.9	63	239	13.8	39	145	0	39	145	41	154		
102	7.7	39	148	10.4	40	153	9.4	42	163	8.4	43	164	7.4	64	246	14.8	39	147	0	39	147	41	156		
96	7.8	39	152	10.8	41	158	9.8	42	163	8.8	44	168	7.8	65	252	15.6	39	149	0	39	149	41	158		
90	7.9	40	158	11.5	42	163	10.5	43	169	9.5	45	174	8.5	67	261	17	39	151	0	39	151	41	160		
77	8	43	169	13.1	44	174	12.1	45	179	11.1	47	185	10.1	70	277	20.2	39	153	0	39	153	41	162		

NOTE: Lt, Lr & w VALUES IN FEET. LISTED RADIUS IS THE MINIMUM ALLOWABLE RADIUS FOR THE CORRESPONDING E, Lt, Lr, AND w VALUES. WIDENING SHOWN IS BASED ON A SU-40 DESIGN VEHICLE.



ROAD AND BRIDGE STANDARDS

SHEET 1 OF 1

REVISION DATE

803.32

01/13

TRANSITION CURVES - RURAL
20 MPH DESIGN SPEED

SPECIFICATION
REFERENCE

VIRGINIA DEPARTMENT OF TRANSPORTATION

DESIGN FACTORS FOR A DESIGN SPEED OF 25 MPH (RURAL) USING E= 8% MAX.

Table with columns for DESIGN VELOCITY (ft/s), DESIGN SOFTWARE EQUIVALENTS (NUMBER OF LANES AT LANE WIDTH) for various widths (18 FT to 118 FT), and INTERCHANGE RAMPS (16 FT to 18 FT). Rows include Lr, Lt, w, and E(%) values for radii from 135 to 2370.

NOTE: Lr, Lt & w VALUES IN FEET. LISTED RADIUS IS THE MINIMUM ALLOWABLE RADIUS FOR THE CORRESPONDING E, Lt, Lr, AND w VALUES. WIDENING SHOWN IS BASED ON A SU-40 DESIGN VEHICLE.

SPECIFICATION REFERENCE

TRANSITION CURVES - RURAL 25 MPH DESIGN SPEED

VIRGINIA DEPARTMENT OF TRANSPORTATION



ROAD AND BRIDGE STANDARDS

REVISION DATE

SHEET 1 OF 1

01/13

803.33

TC-5.11

DESIGN FACTORS FOR A DESIGN SPEED OF 30 MPH (RURAL) USING E= 8% MAX.

DESIGN VELOCITY =30 RADIUS(FT)	WIDTH+ 18 FT		WIDTH+20 FT		WIDTH+22 FT		WIDTH+24 FT		WIDTH+48 FT		INTERCHANGE RAMPS					
	DESIGN SOFTWARE EQUIVALENTS (NUMBER OF LANES AT LANE WIDTH)						WIDTH									
	1 @ 9'		1 @ 10'		1 @ 11'		1 @ 12'		2 @ 12'		16 FT		18 FT			
	Lt	Lr	w	Lt	Lr	w	Lt	Lr	w	Lt	Lr	w	Lt	Lr	Lt	Lr
3240	NC	0	0	0	0	0	0	0	0	0	0	0	0	0	0	0
2400	2	31	2	31	31	0	34	34	0	37	37	0	55	55	0	43
2360	2.1	31	32	2	31	32	0	34	35	0	37	39	0	55	58	0
2200	2.2	31	34	2	31	34	0	34	37	0	37	40	0	55	60	0
2040	2.3	31	36	2.1	31	35	0	34	39	0	37	42	0	55	63	0
2000	2.4	31	37	2.1	31	37	0	34	40	0	37	44	0	55	66	0
1920	2.5	32	39	2.1	31	38	0	34	42	0	37	46	0	55	69	0
1840	2.6	31	40	2.1	31	40	0	34	44	0	37	48	0	55	71	0
1760	2.7	32	42	2.2	31	41	0	34	45	0	37	50	0	55	74	0
1680	2.8	31	43	2.2	31	43	0	34	47	0	37	51	0	55	77	0
1600	2.9	32	45	2.3	31	44	0	34	49	0	37	53	0	55	80	0
1520	3	32	47	2.3	31	46	0	34	50	0	37	55	0	55	82	0
1440	3.1	31	48	2.3	31	47	0	34	52	0	37	57	0	55	85	0
1430	3.2	32	50	2.4	31	49	0	34	54	0	37	59	0	55	88	0
1352	3.3	31	51	2.4	31	50	0	34	55	0	37	60	0	55	90	0
1288	3.4	32	53	2.5	31	52	0	34	57	0	37	62	0	55	93	0
1259	3.5	32	55	2.5	31	54	0	34	59	0	37	64	0	55	96	0
1203	3.6	32	56	2.5	31	55	0	34	60	0	37	66	0	55	99	0
1182	3.7	32	58	2.5	31	57	0	34	62	0	37	68	0	55	101	0
1120	3.8	32	60	2.6	31	58	0	34	64	0	37	70	0	55	104	0
1090	3.9	32	61	2.6	31	60	0	34	65	0	37	71	0	55	107	0
1038	4	32	63	2.7	31	61	0	34	67	0	37	73	0	55	110	0
1010	4.1	32	65	2.7	31	63	0	34	69	0	37	75	0	55	112	0
980	4.2	32	67	2.8	31	64	0	34	70	0	37	77	0	55	115	0
941	4.3	32	68	2.8	31	66	0	34	72	0	37	79	0	55	118	0
910	4.4	32	70	2.9	31	67	0	34	74	0	37	80	0	55	120	0
878	4.5	32	72	2.9	31	69	0	34	75	0	37	82	0	55	123	0
863	4.6	32	73	2.9	31	70	0	34	77	0	37	84	0	55	126	0
824	4.7	32	75	3	34	79	2	34	79	2	37	86	0	55	129	0
807	4.8	33	77	3	34	80	2	34	80	2	37	88	0	55	131	0
781	4.9	33	79	3.1	34	83	2.1	34	82	0	37	90	0	55	134	0
742	5	32	80	3.1	34	84	2.1	34	84	0	37	91	0	55	137	0
731	5.1	33	82	3.2	34	86	2.2	34	85	0	37	93	0	55	140	0
698	5.2	33	84	3.2	34	88	2.2	34	87	0	37	95	0	55	142	0
675	5.3	33	86	3.3	34	90	2.3	34	89	0	37	97	0	55	145	0
647	5.4	33	88	3.4	34	92	2.4	34	90	0	37	99	0	55	148	0
626	5.5	33	90	3.4	35	94	2.4	34	92	0	37	100	0	55	150	0
604	5.6	33	92	3.5	35	96	2.5	34	94	0	37	102	0	55	153	0
573	5.7	33	94	3.6	35	98	2.6	34	95	0	37	104	0	55	156	0
565	5.8	33	95	3.6	35	100	2.6	34	97	0	37	106	0	55	159	0
543	5.9	33	97	3.7	35	102	2.7	34	99	0	37	108	0	55	161	0
522	6	34	100	3.8	35	104	2.8	34	100	0	37	110	0	55	164	0
510	6.1	34	101	3.8	35	106	2.8	34	102	0	37	111	0	55	167	0
486	6.2	34	103	3.9	35	108	2.9	34	104	0	37	113	0	55	170	0
464	6.3	34	105	4	35	110	3	37	115	2	37	115	0	55	172	0
450	6.4	34	108	4.1	35	112	3.1	37	117	2.1	37	117	0	55	175	0
440	6.5	34	109	4.1	36	114	3.1	37	119	2.1	37	119	0	55	178	0
430	6.6	34	111	4.2	36	116	3.2	37	121	2.2	37	120	0	55	180	0
410	6.7	35	114	4.3	36	119	3.3	37	124	2.3	37	122	0	55	183	0
400	6.8	35	116	4.4	36	121	3.4	37	126	2.4	37	124	0	55	186	0
390	6.9	35	118	4.5	36	123	3.5	38	129	2.5	37	126	0	55	189	0
371	7	35	120	4.6	36	126	3.6	38	131	2.6	37	128	0	55	191	0
360	7.1	35	123	4.7	37	128	3.7	38	133	2.7	37	130	0	55	194	0
343	7.2	35	125	4.8	37	130	3.8	38	136	2.8	37	131	0	55	197	0
332	7.3	35	127	4.9	37	133	3.9	38	138	2.9	37	133	0	55	200	0
320	7.4	35	129	5	37	135	4	39	141	3	40	146	2	60	219	4
309	7.5	36	132	5.1	37	137	4.1	39	143	3.1	40	149	2.1	60	223	4.2
298	7.6	36	135	5.3	37	140	4.3	39	146	3.3	40	152	2.3	60	228	4.6
280	7.7	36	138	5.5	38	143	4.5	39	149	3.5	41	155	2.5	61	232	5
271	7.8	36	140	5.6	38	146	4.6	39	152	3.6	41	158	2.6	61	236	5.2
259	7.9	37	143	5.8	38	149	4.8	40	155	3.8	41	161	2.8	62	241	5.6
215	8	38	149	6.5	39	155	5.5	41	161	4.5	42	167	3.5	63	250	7

NOTE:
Lt, Lr & w VALUES IN FEET. LISTED RADIUS IS THE MINIMUM ALLOWABLE RADIUS FOR THE CORRESPONDING E, Lt, Lr, AND w VALUES.
WIDENING SHOWN IS BASED ON A SU-40 DESIGN VEHICLE.



ROAD AND BRIDGE STANDARDS

SHEET 1 OF 1 REVISION DATE

803.34 01/13

TRANSITION CURVES - RURAL
30 MPH DESIGN SPEED

VIRGINIA DEPARTMENT OF TRANSPORTATION

SPECIFICATION REFERENCE

NOTE: Lr, Lt & w VALUES IN FEET. LISTED RADIUS IS THE MINIMUM ALLOWABLE RADIUS FOR THE CORRESPONDING E, Lt, Lr, AND w VALUES. WIDENING SHOWN IS BASED ON A WB-62 DESIGN VEHICLE.

DESIGN FACTORS FOR A DESIGN SPEED OF 40 MPH (RURAL) USING E = 8% MAX.

DESIGN VELOCITY +40	DESIGN SOFTWARE EQUIVALENTS (NUMBER OF LANES AT LANE WIDTH)																		INTERCHANGE RAMPS								
	WIDTH= 18 FT			WIDTH=20 FT			WIDTH=22 FT			WIDTH=24 FT			WIDTH=48 FT			WIDTH=72 FT			WIDTH=112 FT			16 FT			18 FT		
	1 @ 9'			1 @ 10'			1 @ 11'			1 @ 12'			2 @ 12'			3 @ 12'			w			w			w		
	Lt	Lr	w	Lt	Lr	w	Lt	Lr	w	Lt	Lr	w	Lt	Lr	w	Lt	Lr	w	Lt	Lr	w	Lt	Lr	w	Lt	Lr	w
	E(%)	NC	0	3	0	2	0	0	0	0	0	0	0	0	0	0	0	0	0	0	0	0	0	0	0	0	
5410	NC	0	3	0	2	0	0	0	0	0	0	0	0	0	0	0	0	0	0	0	0	0	0	0			
4120	2	37	37	3.1	39	39	2.1	38	38	0	42	42	0	63	63	0	83	83	0	83	83	0	49	49	52		
3920	2.1	37	39	3.2	39	41	2.2	38	40	0	42	44	0	63	66	0	83	87	0	83	87	0	49	51	54		
3640	2.2	37	41	3.2	39	43	2.2	38	42	0	42	46	0	63	69	0	83	92	0	83	92	0	49	54	57		
3480	2.3	37	43	3.3	39	45	2.3	38	44	0	42	48	0	63	72	0	83	96	0	83	96	0	49	56	60		
3400	2.4	37	45	3.3	39	47	2.3	38	46	0	42	50	0	63	75	0	83	100	0	83	100	0	49	59	62		
3160	2.5	37	47	3.4	39	49	2.4	38	48	0	42	52	0	63	78	0	83	104	0	83	104	0	49	61	65		
3094	2.6	37	48	3.4	39	51	2.4	38	50	0	42	54	0	63	81	0	83	108	0	83	108	0	49	64	67		
2970	2.7	37	50	3.4	39	53	2.4	38	52	0	42	56	0	63	84	0	83	112	0	83	112	0	49	66	70		
2784	2.8	84	52	3.5	39	55	2.5	38	54	0	42	58	0	63	87	0	83	116	0	83	116	0	49	68	72		
2712	2.9	81	54	3.5	39	57	2.5	38	55	0	42	60	0	63	90	0	83	120	0	83	120	0	49	71	75		
2556	3	78	56	3.6	39	59	2.6	38	57	0	42	63	0	63	94	0	83	125	0	83	125	0	49	73	78		
2472	3.1	76	58	3.6	39	61	2.6	38	59	0	42	65	0	63	97	0	83	129	0	83	129	0	49	76	80		
2395	3.2	74	60	3.7	40	63	2.7	38	61	0	42	67	0	63	100	0	83	133	0	83	133	0	49	78	82		
2294	3.3	71	62	3.7	40	65	2.7	38	63	0	42	69	0	63	103	0	83	137	0	83	137	0	49	80	85		
2212	3.4	69	64	3.8	40	67	2.8	38	65	0	42	71	0	63	106	0	83	141	0	83	141	0	49	83	88		
2171	3.5	67	66	3.8	40	69	2.8	38	67	0	42	73	0	63	109	0	83	145	0	83	145	0	49	85	90		
2073	3.6	65	68	3.9	40	72	2.9	38	69	0	42	75	0	63	112	0	83	149	0	83	149	0	49	88	93		
2001	3.7	64	70	3.9	40	74	2.9	38	71	0	42	77	0	63	115	0	83	154	0	83	154	0	49	90	96		
1941	3.8	62	73	4	40	76	3	42	79	2	42	79	0	63	118	0	83	158	0	83	158	0	49	93	98		
1856	3.9	60	74	4	40	78	3	42	81	2	42	81	0	63	122	0	83	162	0	83	162	0	49	95	101		
1800	4	59	77	4.1	40	80	3.1	42	84	2.1	42	83	0	63	125	0	83	166	0	83	166	0	49	97	103		
1744	4.1	58	79	4.1	40	82	3.1	42	86	2.1	42	85	0	63	128	0	83	170	0	83	170	0	49	100	106		
1689	4.2	56	81	4.2	40	84	3.2	42	88	2.2	42	87	0	63	131	0	83	174	0	83	174	0	49	102	108		
1635	4.3	55	83	4.2	40	86	3.2	42	90	2.2	42	89	0	63	134	0	83	178	0	83	178	0	49	105	111		
1581	4.4	54	85	4.3	41	89	3.3	42	93	2.3	42	92	0	63	137	0	83	183	0	83	183	0	49	107	114		
1527	4.5	52	87	4.3	41	91	3.3	42	95	2.3	42	94	0	63	140	0	83	187	0	83	187	0	49	110	116		
1502	4.6	51	89	4.4	41	93	3.4	43	97	2.4	42	96	0	63	143	0	83	191	0	83	191	0	49	112	119		
1477	4.7	50	91	4.4	41	95	3.4	43	99	2.4	42	98	0	63	146	0	83	195	0	83	195	0	49	114	121		
1424	4.8	49	94	4.5	41	98	3.5	43	102	2.5	42	100	0	63	149	0	83	199	0	83	199	0	49	117	124		
1368	4.9	48	96	4.5	41	100	3.5	43	104	2.5	42	102	0	63	153	0	83	203	0	83	203	0	49	119	126		
1346	5	47	98	4.6	41	102	3.6	43	107	2.6	42	104	0	63	156	0	83	207	0	83	207	0	49	122	129		
1296	5.1	46	100	4.7	41	105	3.7	43	109	2.7	42	106	0	63	159	0	83	212	0	83	212	0	49	124	132		
1267	5.2	45	102	4.7	41	107	3.7	43	111	2.7	42	108	0	63	162	0	83	216	0	83	216	0	49	127	134		
1220	5.3	45	105	4.8	42	109	3.8	43	114	2.8	42	110	0	63	165	0	83	220	0	83	220	0	49	129	137		
1190	5.4	44	107	4.8	42	111	3.8	43	116	2.8	42	112	0	63	168	0	83	224	0	83	224	0	49	131	139		
1160	5.5	43	109	4.9	42	114	3.9	43	119	2.9	42	114	0	63	171	0	83	228	0	83	228	0	49	134	142		
1101	5.6	42	112	5	42	116	4	44	121	3	45	126	2	68	189	4	90	252	6	49	252	6	49	136	144		
1081	5.7	42	114	5.1	42	119	4.1	44	124	3.1	45	129	2.1	68	193	4.2	90	257	6.3	49	257	6.3	49	139	147		
1054	5.8	41	116	5.1	42	121	4.1	44	126	3.1	45	131	2.1	68	196	4.2	90	261	6.3	49	261	6.3	49	141	150		
1025	5.9	40	118	5.2	42	124	4.2	44	129	3.2	46	134	2.2	68	200	4.4	91	267	6.6	49	267	6.6	49	144	152		
988	6	41	121	5.3	42	126	4.3	44	131	3.3	46	137	2.3	69	205	4.6	91	273	6.9	49	273	6.9	49	146	155		
957	6.1	41	124	5.4	43	129	4.4	44	134	3.4	46	139	2.4	69	209	4.8	92	278	7.2	49	278	7.2	49	148	157		
942	6.2	41	126	5.4	43	131	4.4	44	136	3.4	46	142	2.4	69	212	4.8	92	283	7.2	49	283	7.2	49	151	160		
912	6.3	41	128	5.5	43	134	4.5	44	139	3.5	46	144	2.5	69	216	5	92	288	7.5	49	288	7.5	49	153	162		
875	6.4	41	131	5.6	43	136	4.6	45	142	3.6	46	147	2.6	69	221	5.2	92	294	7.8	49	294	7.8	49	156	165		
866	6.5	41	133	5.6	43	138	4.6	45	144	3.6	46	150	2.6	69	224	5.2	92	299	7.8	49	299	7.8	49	158	168		
837	6.6	41	135	5.7	43	141	4.7	45	147	3.7	47	152	2.7	70	228	5.4	93	304	8.1	49	304	8.1	49	160	170		
806	6.7	42	139	5.9	43	144	4.9	45	150	3.9	47	156	2.9	70	234	5.8	93	311	8.7	49	311	8.7	49	163	173		
782	6.8	42	141	6	44	147	5	45	153	4	47	159	3	70	238	6	94	317	9	49	317	9	49	165	175		
754	6.9	42	144	6.1	44	150	5.1	45	156	4.1	47	162	3.1	71	242	6.2	94	323	9.3	49	323	9.3	49	168	178		
744	7	42	146	6.1	44	152	5.1	45	158	4.1	47	164	3.1	71	246	6.2	94	328	9.3	49	328	9.3	49	170	180		
714	7.1	42	149	6.3	44	155	5.3	46	161	4.3	48	168	3.3	71	251	6.6	95	335	9.9	49	335	9.9	49	173	183		
692	7.2	43	152	6.4	44	158	5.4	46	164	4.4	48	171	3.4	71	256	6.8	95	341	10.2	49	341	10.2	49	175	186		
663	7.3	43	155	6.5	45	161	5.5	46	167	4.5	48	174	3.5	72	260	7	95	347	10.5	49	347	10.5	49	177	188		
651	7.4	43	157	6.6	45	164	5.6	46	170	4.6	48	177	3.6	72	265	7.2	96	353	10.8	49	353	10.8	49	180	191		
622	7.5	43	161	6.8	45	167	5.8	47	174	4.8	48	180	3.8	72	270	7.6	96	360	11.4	49	360	11.4	49	182	193		
597	7.6	44	164	6.9	45	170	5.9	47	177	4.9	49	183	3.9	73	275	7.8	97	366	11.7	49	366	11.7	49	185	196		
581	7.7	44	166	7	45	173	6	47	180	5	49	186	4	73	279	8	97	372	12</								

DESIGN FACTORS FOR A DESIGN SPEED OF 45 MPH (RURAL) USING E = 8% MAX.

DESIGN VELOCITY +45 RADIUS(FT)	E(%)	DESIGN SOFTWARE EQUIVALENTS (NUMBER OF LANES AT LANE WIDTH)										INTERCHANGE RAMP WIDTH						
		WIDTH+20 FT		WIDTH+22 FT		WIDTH+24 FT		WIDTH+48 FT		WIDTH+72 FT		16 FT		18 FT				
		1 @ 10'		1 @ 11'		1 @ 12'		2 @ 12'		3 @ 12'		Lt	Lr	Lt	Lr			
		Lt	w	Lt	w	Lt	w	Lt	w	Lt	w	Lt	w	Lt	w	Lt	w	
6710	NC	0	0	0	0	0	0	0	0	0	0	0	0	0	0	0	0	
5180	2	41	41	2	41	41	0	45	45	0	67	67	0	89	89	0	53	53
4730	2.1	41	43	2.1	41	43	0	45	47	0	67	70	0	89	94	0	53	56
4560	2.2	41	46	2.1	41	45	0	45	49	0	67	74	0	89	98	0	53	58
4350	2.3	42	48	2.2	41	47	0	45	52	0	67	77	0	89	103	0	53	61
4080	2.4	42	50	2.2	41	49	0	45	54	0	67	80	0	89	107	0	53	64
3930	2.5	42	52	2.3	41	51	0	45	56	0	67	84	0	89	112	0	53	67
3780	2.6	42	54	2.3	41	53	0	45	58	0	67	87	0	89	116	0	53	72
3630	2.7	42	56	2.3	41	55	0	45	60	0	67	90	0	89	120	0	53	75
3450	2.8	42	59	2.4	41	58	0	45	63	0	67	94	0	89	125	0	53	78
3270	2.9	42	61	2.4	41	60	0	45	65	0	67	97	0	89	129	0	53	81
3150	3	42	63	2.5	41	62	0	45	67	0	67	100	0	89	134	0	53	84
3030	3.1	42	65	2.5	41	64	0	45	69	0	67	104	0	89	138	0	53	86
2920	3.2	42	67	2.5	41	66	0	45	72	0	67	107	0	89	143	0	53	89
2840	3.3	42	70	2.6	41	68	0	45	74	0	67	110	0	89	147	0	53	92
2784	3.4	42	72	2.6	41	70	0	45	76	0	67	114	0	89	152	0	53	95
2670	3.5	42	74	2.6	41	72	0	45	78	0	67	117	0	89	156	0	53	97
2606	3.6	43	76	2.7	41	74	0	45	80	0	67	120	0	89	160	0	53	100
2498	3.7	43	78	2.7	41	76	0	45	83	0	67	124	0	89	165	0	53	103
2393	3.8	43	81	2.8	41	78	0	45	85	0	67	127	0	89	169	0	53	106
2355	3.9	43	83	2.8	41	80	0	45	87	0	67	130	0	89	174	0	53	108
2261	4	43	85	2.9	41	82	0	45	89	0	67	134	0	89	178	0	53	111
2183	4.1	43	87	2.9	41	84	0	45	92	0	67	137	0	89	183	0	53	114
2126	4.2	43	90	2.9	41	86	0	45	94	0	67	140	0	89	187	0	53	117
2069	4.3	43	92	3	45	96	2	45	96	0	67	144	0	89	192	0	53	120
2012	4.4	43	94	3	45	98	2	45	98	0	67	147	0	89	196	0	53	122
1955	4.5	43	97	3.1	45	101	2.1	45	100	0	67	150	0	89	200	0	53	125
1878	4.6	43	99	3.1	45	103	2.1	45	103	0	67	154	0	89	205	0	53	128
1820	4.7	43	101	3.2	45	106	2.2	45	105	0	67	157	0	89	209	0	53	131
1788	4.8	43	104	3.2	45	108	2.2	45	107	0	67	160	0	89	214	0	53	133
1739	4.9	43	106	3.2	45	110	2.2	45	109	0	67	164	0	89	218	0	53	136
1703	5	44	108	3.3	45	113	2.3	45	112	0	67	167	0	89	223	0	53	139
1652	5.1	44	111	3.3	45	115	2.3	45	114	0	67	170	0	89	227	0	53	142
1578	5.2	44	113	3.4	46	118	2.4	45	116	0	67	174	0	89	232	0	53	144
1535	5.3	44	116	3.5	46	121	2.5	45	118	0	67	177	0	89	236	0	53	147
1496	5.4	44	118	3.5	46	123	2.5	45	120	0	67	180	0	89	240	0	53	150
1464	5.5	44	120	3.5	46	125	2.5	45	123	0	67	184	0	89	245	0	53	153
1419	5.6	44	123	3.6	46	128	2.6	45	125	0	67	187	0	89	249	0	53	156
1378	5.7	44	126	3.7	46	131	2.7	45	127	0	67	190	0	89	254	0	53	158
1324	5.8	44	128	3.7	46	133	2.7	45	129	0	67	194	0	89	258	0	53	161
1306	5.9	45	131	3.8	46	136	2.8	45	132	0	67	197	0	89	263	0	53	164
1261	6	45	133	3.9	47	139	2.9	45	134	0	67	200	0	89	267	0	53	167
1240	6.1	45	135	3.9	47	141	2.9	45	136	0	67	204	0	89	272	0	53	169
1196	6.2	45	138	4	47	144	3	49	150	2	73	224	4	97	299	6	53	172
1173	6.3	45	140	4	47	146	3	49	152	2	73	228	4	97	304	6	53	175
1150	6.4	45	143	4.1	47	149	3.1	49	155	2.1	73	232	4.2	97	310	6.3	53	178
1103	6.5	45	146	4.2	47	152	3.2	49	158	2.2	73	237	4.4	98	316	6.6	53	180
1079	6.6	45	148	4.2	47	154	3.2	49	161	2.2	73	241	4.4	98	321	6.6	53	183
1054	6.7	45	151	4.3	47	157	3.3	49	164	2.3	74	245	4.6	98	327	6.9	53	186
1000	6.8	46	154	4.4	48	160	3.4	49	167	2.4	74	250	4.8	98	333	7.2	53	189
986	6.9	46	156	4.4	48	163	3.4	49	169	2.4	74	253	4.8	98	338	7.2	53	192
948	7	46	160	4.6	48	166	3.6	50	173	2.6	74	259	5.2	99	345	7.8	53	194
933	7.1	46	162	4.6	48	169	3.6	50	175	2.6	74	263	5.2	99	350	7.8	53	197
896	7.2	46	165	4.7	48	172	3.7	50	178	2.7	75	267	5.4	99	356	8.1	53	200
858	7.3	47	168	4.8	48	175	3.8	50	182	2.8	75	272	5.6	100	363	8.4	53	203
846	7.4	47	171	4.9	48	178	3.9	50	185	2.9	75	277	5.8	100	369	8.7	53	205
807	7.5	47	174	5	49	181	4	50	188	3	75	282	6	100	375	9	53	208
800	7.6	47	177	5.1	49	184	4.1	51	191	3.1	76	287	6.2	101	382	9.3	53	211
760	7.7	47	180	5.2	49	187	4.2	51	194	3.2	76	291	6.4	101	388	9.6	53	214
720	7.8	48	184	5.4	49	191	4.4	51	198	3.4	77	297	6.8	102	396	10.2	53	216
680	7.9	48	188	5.6	50	195	4.6	52	202	3.6	77	303	7.2	103	404	10.8	53	219
589	8	49	195	6.2	51	202	5.2	53	209	4.2	79	314	8.4	105	418	12.6	53	222

NOTE: Lt, Lr & w VALUES IN FEET. LISTED RADIUS IS THE MINIMUM ALLOWABLE RADIUS FOR THE CORRESPONDING E, Lt, Lr, AND w VALUES. WIDENING SHOWN IS BASED ON A WB-62 DESIGN VEHICLE.

SPECIFICATION REFERENCE

TRANSITION CURVES - RURAL 45 MPH DESIGN SPEED

VIRGINIA DEPARTMENT OF TRANSPORTATION



ROAD AND BRIDGE STANDARDS

REVISION DATE	SHEET 1 OF 1
01/13	803.37

DESIGN VELOCITY -50	DESIGN SOFTWARE EQUIVALENTS (NUMBER OF LANES AT LANE WIDTH)												INTERCHANGE RAMPS			
	WIDTH-20 FT			WIDTH-22 FT			WIDTH-24 FT			WIDTH-48 FT			WIDTH-72 FT		18 FT	
	Lt	Lr	w	Lt	Lr	w	Lt	Lr	w	Lt	Lr	w	Lt	Lr	Lt	Lr
8150	NC	0	0	0	0	0	0	0	0	0	0	0	0	0	0	0
6013	2	44	44	2	44	44	0	48	48	0	72	72	0	96	96	0
5703	2.1	45	47	2.1	44	47	0	48	51	0	72	76	0	96	101	0
5420	2.2	45	49	2.1	44	49	0	48	53	0	72	80	0	96	106	0
5162	2.3	45	51	2.1	44	51	0	48	56	0	72	83	0	96	111	0
4926	2.4	45	54	2.2	44	53	0	48	58	0	72	87	0	96	116	0
4708	2.5	45	56	2.2	44	55	0	48	60	0	72	90	0	96	120	0
4507	2.6	45	58	2.2	44	58	0	48	63	0	72	94	0	96	125	0
4320	2.7	45	61	2.3	44	60	0	48	65	0	72	98	0	96	130	0
4146	2.8	45	63	2.3	44	62	0	48	68	0	72	101	0	96	135	0
3985	2.9	45	65	2.3	44	64	0	48	70	0	72	105	0	96	140	0
3834	3	45	68	2.4	44	66	0	48	72	0	72	108	0	96	144	0
3692	3.1	45	70	2.4	44	69	0	48	75	0	72	112	0	96	149	0
3560	3.2	45	72	2.4	44	71	0	48	77	0	72	116	0	96	154	0
3434	3.3	45	75	2.5	44	73	0	48	80	0	72	119	0	96	159	0
3316	3.4	45	77	2.5	44	75	0	48	82	0	72	123	0	96	164	0
3205	3.5	45	79	2.5	44	77	0	48	84	0	72	126	0	96	168	0
3099	3.6	46	82	2.6	44	80	0	48	87	0	72	130	0	96	173	0
2999	3.7	46	84	2.6	44	82	0	48	89	0	72	134	0	96	178	0
2904	3.8	46	86	2.6	44	84	0	48	92	0	72	137	0	96	183	0
2814	3.9	46	89	2.7	44	86	0	48	94	0	72	141	0	96	188	0
2728	4	46	91	2.7	44	88	0	48	96	0	72	144	0	96	192	0
2646	4.1	46	94	2.8	44	91	0	48	99	0	72	148	0	96	197	0
2568	4.2	46	96	2.8	44	93	0	48	101	0	72	152	0	96	202	0
2493	4.3	46	99	2.8	44	95	0	48	104	0	72	155	0	96	207	0
2422	4.4	46	101	2.9	44	97	0	48	106	0	72	159	0	96	212	0
2353	4.5	46	104	2.9	44	99	0	48	108	0	72	162	0	96	216	0
2287	4.6	46	106	2.9	44	102	0	48	111	0	72	166	0	96	221	0
2224	4.7	46	109	3	48	113	2	48	113	0	72	170	0	96	226	0
2163	4.8	46	111	3	48	116	2	48	116	0	72	173	0	96	231	0
2104	4.9	47	114	3.1	49	119	2.1	48	118	0	72	177	0	96	236	0
2047	5	47	116	3.1	49	121	2.1	48	120	0	72	180	0	96	240	0
1992	5.1	47	118	3.1	49	123	2.1	48	123	0	72	184	0	96	245	0
1939	5.2	47	121	3.2	49	126	2.2	48	125	0	72	188	0	96	250	0
1888	5.3	47	123	3.2	49	129	2.2	48	128	0	72	191	0	96	255	0
1838	5.4	47	126	3.3	49	132	2.3	48	130	0	72	195	0	96	260	0
1790	5.5	47	129	3.3	49	134	2.3	48	132	0	72	198	0	96	264	0
1743	5.6	47	132	3.4	49	137	2.4	48	135	0	72	202	0	96	269	0
1698	5.7	47	134	3.4	49	140	2.4	48	137	0	72	206	0	96	274	0
1653	5.8	47	137	3.5	49	143	2.5	48	140	0	72	209	0	96	279	0
1610	5.9	47	139	3.5	49	145	2.5	48	142	0	72	213	0	96	284	0
1568	6	47	141	3.5	49	147	2.5	48	144	0	72	216	0	96	288	0
1527	6.1	48	144	3.6	50	151	2.6	48	147	0	72	220	0	96	293	0
1487	6.2	48	147	3.6	50	153	2.6	48	149	0	72	224	0	96	298	0
1448	6.3	48	150	3.7	50	156	2.7	48	152	0	72	227	0	96	303	0
1410	6.4	48	153	3.8	50	159	2.8	48	154	0	72	231	0	96	308	0
1372	6.5	48	155	3.8	50	162	2.8	48	156	0	72	234	0	96	312	0
1336	6.6	48	158	3.9	50	165	2.9	48	159	0	72	238	0	96	317	0
1300	6.7	48	161	3.9	50	167	2.9	48	161	0	72	242	0	96	322	0
1265	6.8	48	164	4	50	170	3	52	177	2	78	266	4	104	354	6
1230	6.9	48	166	4	50	173	3	52	180	2	78	270	4	104	359	6
1196	7	49	169	4.1	51	176	3.1	53	183	2.1	79	275	4.2	105	366	6.3
1162	7.1	49	172	4.2	51	179	3.2	53	187	2.2	79	280	4.4	105	373	6.6
1128	7.2	49	175	4.3	51	183	3.3	53	190	2.3	79	285	4.6	106	379	6.9
1094	7.3	49	178	4.3	51	185	3.3	53	192	2.3	79	288	4.6	106	384	6.9
1059	7.4	49	181	4.4	51	188	3.4	53	196	2.4	80	294	4.8	106	391	7.2
1024	7.5	50	184	4.5	51	192	3.5	53	199	2.5	80	299	5	106	398	7.5
988	7.6	50	187	4.6	52	195	3.6	54	203	2.6	80	304	5.2	107	405	7.8
950	7.7	50	191	4.7	52	198	3.7	54	206	2.7	81	309	5.4	107	412	8.1
908	7.8	50	194	4.8	52	202	3.8	54	210	2.8	81	314	5.6	108	419	8.4
860	7.9	51	198	5	52	206	4	54	214	3	81	320	6	108	427	9
760	8	51	204	5.4	53	212	4.4	55	220	3.4	83	329	6.8	110	439	10.2

NOTE: Lt, Lr & w VALUES IN FEET. LISTED RADIUS IS THE MINIMUM ALLOWABLE RADIUS FOR THE CORRESPONDING E, Lt, Lr, AND w VALUES. WIDENING SHOWN IS BASED ON A WB-62 DESIGN VEHICLE.

DESIGN FACTORS FOR A DESIGN SPEED OF 50 MPH (RURAL) USING E= 8% MAX.

VDOT
ROAD AND BRIDGE STANDARDS

SHEET 1 OF 1
803.38

REVISION DATE
01/13

TRANSITION CURVES - RURAL
50 MPH DESIGN SPEED

VIRGINIA DEPARTMENT OF TRANSPORTATION

SPECIFICATION REFERENCE

DESIGN FACTORS FOR A DESIGN SPEED OF 55 MPH (RURAL) USING E= 8% MAX.		DESIGN SOFTWARE EQUIVALENTS (NUMBER OF LANES AT LANE WIDTH)										INTERCHANGE RAMPS					
		WIDTH-22 FT		WIDTH-24 FT		WIDTH-48 FT		WIDTH-72 FT		16 FT		18 FT					
		Lt	Lr	w	Lt	Lr	w	Lt	Lr	w	Lt	Lr	w	Lt	Lr	w	
DESIGN VELOCITY +55	RADIUS(FT)	E(%)	Lt	Lr	w	Lt	Lr	w	Lt	Lr	w	Lt	Lr	w	Lt	Lr	w
	9720	NC	0	0	0	0	0	0	0	0	0	0	0	0	0	0	0
	7190	2	47	47	0	52	52	0	77	77	0	103	103	0	60	60	64
	6821	2.1	47	50	0	52	54	0	77	81	0	103	108	0	60	63	64
	6485	2.2	47	52	0	52	57	0	77	85	0	103	113	0	60	66	64
	6179	2.3	47	54	0	52	59	0	77	89	0	103	118	0	60	69	64
	5897	2.4	47	57	0	52	62	0	77	92	0	103	123	0	60	72	64
	5638	2.5	47	59	0	52	64	0	77	96	0	103	128	0	60	75	64
	5399	2.6	47	61	0	52	67	0	77	100	0	103	133	0	60	78	64
	5177	2.7	47	64	0	52	69	0	77	104	0	103	138	0	60	80	64
	4972	2.8	47	66	0	52	72	0	77	108	0	103	143	0	60	83	64
	4779	2.9	47	68	0	52	75	0	77	112	0	103	149	0	60	86	64
	4600	3	47	71	0	52	77	0	77	115	0	103	154	0	60	89	64
	4432	3.1	47	73	0	52	80	0	77	119	0	103	159	0	60	92	64
	4274	3.2	47	75	0	52	82	0	77	123	0	103	164	0	60	95	64
	4125	3.3	47	78	0	52	85	0	77	127	0	103	169	0	60	98	64
	3986	3.4	47	80	0	52	87	0	77	131	0	103	174	0	60	101	64
	3853	3.5	47	82	0	52	90	0	77	135	0	103	179	0	60	104	64
	3728	3.6	47	85	0	52	92	0	77	138	0	103	184	0	60	107	64
	3610	3.7	47	87	0	52	95	0	77	142	0	103	189	0	60	110	64
	3498	3.8	47	89	0	52	98	0	77	146	0	103	195	0	60	113	64
	3391	3.9	47	92	0	52	100	0	77	150	0	103	200	0	60	116	64
	3289	4	47	94	0	52	103	0	77	154	0	103	205	0	60	119	64
	3192	4.1	47	96	0	52	105	0	77	158	0	103	210	0	60	122	64
	3100	4.2	47	99	0	52	108	0	77	161	0	103	215	0	60	125	64
	3011	4.3	47	101	0	52	110	0	77	165	0	103	220	0	60	128	64
	2927	4.4	47	103	0	52	113	0	77	169	0	103	225	0	60	131	64
	2846	4.5	47	106	0	52	115	0	77	173	0	103	230	0	60	134	64
	2768	4.6	47	108	0	52	118	0	77	177	0	103	235	0	60	137	64
	2693	4.7	47	110	0	52	120	0	77	180	0	103	240	0	60	140	64
	2621	4.8	47	113	0	52	123	0	77	184	0	103	246	0	60	143	64
	2552	4.9	47	115	0	52	126	0	77	188	0	103	251	0	60	146	64
	2486	5	47	118	0	52	128	0	77	192	0	103	256	0	60	149	64
	2421	5.1	52	131	2	52	131	0	77	196	0	103	261	0	60	152	64
	2359	5.2	52	133	2	52	133	0	77	200	0	103	266	0	60	155	64
	2299	5.3	52	136	2	52	136	0	77	203	0	103	271	0	60	158	64
	2241	5.4	52	139	2.1	52	138	0	77	207	0	103	276	0	60	160	64
	2185	5.5	52	142	2.1	52	141	0	77	211	0	103	281	0	60	163	64
	2130	5.6	52	145	2.2	52	143	0	77	215	0	103	286	0	60	166	64
	2077	5.7	52	147	2.2	52	146	0	77	219	0	103	292	0	60	169	64
	2026	5.8	52	150	2.2	52	149	0	77	223	0	103	297	0	60	172	64
	1976	5.9	52	153	2.3	52	151	0	77	226	0	103	302	0	60	175	64
	1927	6	52	156	2.3	52	154	0	77	230	0	103	307	0	60	178	64
	1880	6.1	52	158	2.3	52	156	0	77	234	0	103	312	0	60	181	64
	1833	6.2	52	161	2.4	52	159	0	77	238	0	103	317	0	60	184	64
	1788	6.3	52	164	2.4	52	161	0	77	242	0	103	322	0	60	187	64
	1743	6.4	53	167	2.5	52	164	0	77	246	0	103	327	0	60	190	64
	1700	6.5	53	170	2.5	52	166	0	77	249	0	103	332	0	60	193	64
	1657	6.6	53	173	2.6	52	169	0	77	253	0	103	338	0	60	196	64
	1615	6.7	53	176	2.6	52	172	0	77	257	0	103	343	0	60	199	64
	1573	6.8	53	179	2.7	52	174	0	77	261	0	103	348	0	60	202	64
	1532	6.9	53	182	2.7	52	177	0	77	265	0	103	353	0	60	205	64
	1491	7	53	185	2.8	52	179	0	77	269	0	103	358	0	60	208	64
	1450	7.1	53	188	2.8	52	182	0	77	272	0	103	363	0	60	211	64
	1409	7.2	53	191	2.9	52	184	0	77	276	0	103	368	0	60	214	64
	1369	7.3	54	195	3	56	202	2	83	303	4	111	404	6	60	217	64
	1327	7.4	54	197	3	56	205	2	83	308	4	111	410	6	60	220	64
	1285	7.5	54	201	3.1	56	209	2.1	84	313	4.2	112	417	6.3	60	223	64
	1241	7.6	54	204	3.2	56	212	2.2	84	318	4.4	112	424	6.6	60	226	64
	1195	7.7	54	208	3.3	56	216	2.3	84	324	4.6	112	431	6.9	60	229	64
	1145	7.8	55	211	3.4	57	220	2.4	85	329	4.8	113	439	7.2	60	232	64
	1085	7.9	55	215	3.5	57	223	2.5	85	335	5	113	446	7.5	60	235	64
	964	8	55	220	3.8	58	229	2.8	86	343	5.6	115	457	8.4	60	238	64

TC-5.11

NOTE: Lt, Lr & w VALUES IN FEET. LISTED RADIUS IS THE MINIMUM ALLOWABLE RADIUS FOR THE CORRESPONDING E, Lt, Lr, AND w VALUES. WIDENING SHOWN IS BASED ON A WB-62 DESIGN VEHICLE.

SPECIFICATION REFERENCE

TRANSITION CURVES - RURAL

55 MPH DESIGN SPEED

VIRGINIA DEPARTMENT OF TRANSPORTATION



ROAD AND BRIDGE STANDARDS

REVISION DATE

01/13

SHEET 1 OF 1

803.39

TC - 5.11

NOTE: Lr, Lt & w VALUES IN FEET. LISTED RADIUS IS THE MINIMUM ALLOWABLE RADIUS FOR THE CORRESPONDING E, Lt, Lr, AND w VALUES. WIDENING SHOWN IS BASED ON A WB-62 DESIGN VEHICLE.

DESIGN FACTORS FOR A DESIGN SPEED OF 60 MPH (RURAL) USING E= 8% MAX.

DESIGN VELOCITY +60	DESIGN SOFTWARE EQUIVALENTS (NUMBER OF LANES AT LANE WIDTH)												INTERCHANGE RAMPS			
	WIDTH=22 FT			WIDTH=24 FT			WIDTH=48 FT			WIDTH=72 FT			16 FT		18 FT	
	Lt	Lr	w	Lt	Lr	w	Lt	Lr	w	Lt	Lr	w	Lt	Lr	Lt	Lr
11500	NC	0	0	0	0	0	0	0	0	0	0	0	0	0	0	0
8480	2	49	49	54	54	0	80	80	0	107	107	0	63	63	67	67
8048	2.1	49	52	0	54	56	0	80	84	0	107	112	0	63	66	67
7654	2.2	49	54	0	54	59	0	80	88	0	107	118	0	63	70	67
7294	2.3	49	57	0	54	62	0	80	92	0	107	123	0	63	73	67
6965	2.4	49	59	0	54	64	0	80	96	0	107	128	0	63	76	67
6661	2.5	49	62	0	54	67	0	80	100	0	107	134	0	63	79	67
6381	2.6	49	64	0	54	70	0	80	104	0	107	139	0	63	82	67
6121	2.7	49	66	0	54	72	0	80	108	0	107	144	0	63	85	67
5879	2.8	49	69	0	54	75	0	80	112	0	107	150	0	63	88	67
5654	2.9	49	71	0	54	78	0	80	116	0	107	155	0	63	91	67
5444	3	49	74	0	54	80	0	80	120	0	107	160	0	63	95	67
5247	3.1	49	76	0	54	83	0	80	124	0	107	166	0	63	98	67
5063	3.2	49	79	0	54	86	0	80	128	0	107	171	0	63	101	67
4889	3.3	49	81	0	54	88	0	80	132	0	107	176	0	63	104	67
4725	3.4	49	84	0	54	91	0	80	136	0	107	182	0	63	107	67
4571	3.5	49	86	0	54	94	0	80	140	0	107	187	0	63	110	67
4424	3.6	49	88	0	54	96	0	80	144	0	107	192	0	63	113	67
4286	3.7	49	91	0	54	99	0	80	148	0	107	198	0	63	117	67
3587	4.3	49	106	0	54	115	0	80	172	0	107	230	0	63	135	67
3488	4.4	49	108	0	54	118	0	80	176	0	107	235	0	63	139	67
3394	4.5	49	110	0	54	120	0	80	180	0	107	240	0	63	142	67
3303	4.6	49	113	0	54	123	0	80	184	0	107	246	0	63	145	67
3216	4.7	49	115	0	54	126	0	80	188	0	107	251	0	63	148	67
3133	4.8	49	118	0	54	128	0	80	192	0	107	256	0	63	151	67
3053	4.9	49	120	0	54	131	0	80	196	0	107	262	0	63	154	67
2975	5	49	123	0	54	134	0	80	200	0	107	267	0	63	157	67
2901	5.1	49	125	0	54	136	0	80	204	0	107	272	0	63	160	67
2829	5.2	49	128	0	54	139	0	80	208	0	107	278	0	63	164	67
2759	5.3	49	130	0	54	142	0	80	212	0	107	283	0	63	167	67
2692	5.4	49	132	0	54	144	0	80	216	0	107	288	0	63	170	67
2627	5.5	54	147	2	54	147	0	80	220	0	107	294	0	63	173	67
2565	5.6	54	150	2	54	150	0	80	224	0	107	299	0	63	176	67
2504	5.7	54	152	2	54	152	0	80	228	0	107	304	0	63	179	67
2445	5.8	54	156	2.1	54	155	0	80	232	0	107	310	0	63	182	67
2387	5.9	54	158	2.1	54	158	0	80	236	0	107	315	0	63	186	67
2332	6	54	161	2.1	54	160	0	80	240	0	107	320	0	63	189	67
2277	6.1	54	165	2.2	54	163	0	80	244	0	107	326	0	63	192	67
2225	6.2	54	167	2.2	54	166	0	80	248	0	107	331	0	63	195	67
2173	6.3	54	170	2.2	54	168	0	80	252	0	107	336	0	63	198	67
2122	6.4	54	173	2.3	54	171	0	80	256	0	107	342	0	63	201	67
2072	6.5	54	176	2.3	54	174	0	80	260	0	107	347	0	63	204	67
2022	6.6	54	179	2.3	54	176	0	80	264	0	107	352	0	63	208	67
1974	6.7	55	182	2.4	54	179	0	80	268	0	107	358	0	63	211	67
1925	6.8	55	185	2.4	54	182	0	80	272	0	107	363	0	63	214	67
1877	6.9	55	188	2.5	54	184	0	80	276	0	107	368	0	63	217	67
1830	7	55	191	2.5	54	187	0	80	280	0	107	374	0	63	220	67
1782	7.1	55	195	2.6	54	190	0	80	284	0	107	379	0	63	223	67
1735	7.2	55	197	2.6	54	192	0	80	288	0	107	384	0	63	226	67
1687	7.3	55	201	2.7	54	195	0	80	292	0	107	390	0	63	229	67
1638	7.4	55	204	2.7	54	198	0	80	296	0	107	395	0	63	233	67
1588	7.5	56	207	2.8	54	200	0	80	300	0	107	400	0	63	236	67
1537	7.6	56	210	2.8	54	203	0	80	304	0	107	406	0	63	239	67
1482	7.7	56	214	2.9	54	206	0	80	308	0	107	411	0	63	242	67
1422	7.8	56	217	3	58	226	2	87	338	4	116	451	6	63	245	67
1350	7.9	56	221	3.1	58	230	2.1	87	344	4.2	116	459	6.3	63	248	67
1204	8	57	226	3.4	59	235	2.4	88	352	4.8	118	470	7.2	63	251	67



ROAD AND BRIDGE STANDARDS

SHEET 1 OF 1

REVISION DATE

803.40

01/13

**TRANSITION CURVES - RURAL
60 MPH DESIGN SPEED**

VIRGINIA DEPARTMENT OF TRANSPORTATION

SPECIFICATION REFERENCE

DESIGN FACTORS FOR A DESIGN SPEED OF 65 MPH (RURAL) USING E = 8% MAX.																																						
DESIGN VELOCITY +65 RADIUS(FT) E(%)	DESIGN SOFTWARE EQUIVALENTS (NUMBER OF LANES AT LANE WIDTH)										WIDTH-48 FT						WIDTH-72 FT						INTERCHANGE RAMPS															
	WIDTH-22 FT					WIDTH-24 FT					1 @ 12'					2 @ 12'					3 @ 12'					16 FT				18 FT								
	Lt	Lr	w	Lt	Lr	w	Lt	Lr	w	Lt	Lr	w	Lt	Lr	w	Lt	Lr	w	Lt	Lr	w	Lt	Lr	w	Lt	Lr	w	Lt	Lr	w	Lt	Lr	w	Lt	Lr	w		
12900	NC																																					
9566	2		52	52	0	56	56	0	84	84	0	112	112	0	84	84	0	112	112	0	112	112	0	112	112	0	66	66	70	70	70	70	70	70	70			
9083	2.1		52	54	0	56	59	0	84	88	0	112	118	0	84	93	0	112	123	0	112	123	0	112	123	0	66	72	70	77	77	77	77	77	77			
864.3	2.2		52	57	0	56	62	0	84	93	0	112	129	0	84	97	0	112	134	0	112	134	0	112	134	0	66	76	70	80	80	80	80	80	80			
824.2	2.3		52	59	0	56	65	0	84	97	0	112	129	0	84	101	0	112	134	0	112	134	0	112	134	0	66	76	70	84	84	84	84	84	84			
787.3	2.4		52	62	0	56	67	0	84	101	0	112	129	0	84	105	0	112	140	0	112	146	0	112	146	0	66	82	70	87	87	87	87	87	87	87		
7534	2.5		52	64	0	56	70	0	84	105	0	112	140	0	84	109	0	112	146	0	112	146	0	112	146	0	66	85	70	90	90	90	90	90	90	90		
7221	2.6		52	67	0	56	73	0	84	109	0	112	146	0	84	114	0	112	151	0	112	157	0	112	157	0	66	92	70	94	94	94	94	94	94	94	94	
6931	2.7		52	70	0	56	76	0	84	114	0	112	157	0	84	118	0	112	162	0	112	162	0	112	162	0	66	92	70	97	97	97	97	97	97	97	97	
6662	2.8		52	72	0	56	79	0	84	118	0	112	162	0	84	122	0	112	167	0	112	173	0	112	173	0	66	95	70	101	101	101	101	101	101	101	101	
6411	2.9		52	75	0	56	81	0	84	122	0	112	167	0	84	126	0	112	168	0	112	174	0	112	174	0	66	98	70	104	104	104	104	104	104	104	104	104
6176	3		52	77	0	56	84	0	84	126	0	112	168	0	84	130	0	112	174	0	112	179	0	112	179	0	66	102	70	108	108	108	108	108	108	108	108	108
5957	3.1		52	80	0	56	87	0	84	130	0	112	174	0	84	134	0	112	185	0	112	185	0	112	185	0	66	105	70	111	111	111	111	111	111	111	111	111
5751	3.2		52	82	0	56	90	0	84	134	0	112	185	0	84	139	0	112	190	0	112	190	0	112	190	0	66	108	70	115	115	115	115	115	115	115	115	115
5557	3.3		52	85	0	56	93	0	84	139	0	112	190	0	84	143	0	112	196	0	112	196	0	112	196	0	66	112	70	118	118	118	118	118	118	118	118	118
5375	3.4		52	87	0	56	95	0	84	143	0	112	196	0	84	147	0	112	201	0	112	201	0	112	201	0	66	118	70	122	122	122	122	122	122	122	122	122
5203	3.5		52	90	0	56	98	0	84	147	0	112	201	0	84	151	0	112	207	0	112	207	0	112	207	0	66	121	70	125	125	125	125	125	125	125	125	125
5040	3.6		52	93	0	56	101	0	84	151	0	112	207	0	84	155	0	112	213	0	112	213	0	112	213	0	66	125	70	132	132	132	132	132	132	132	132	132
4886	3.7		52	95	0	56	104	0	84	155	0	112	213	0	84	160	0	112	218	0	112	218	0	112	218	0	66	128	70	135	135	135	135	135	135	135	135	135
4740	3.8		52	98	0	56	107	0	84	160	0	112	218	0	84	164	0	112	224	0	112	224	0	112	224	0	66	131	70	139	139	139	139	139	139	139	139	139
4601	3.9		52	100	0	56	109	0	84	164	0	112	218	0	84	168	0	112	229	0	112	229	0	112	229	0	66	134	70	142	142	142	142	142	142	142	142	142
4469	4		52	103	0	56	112	0	84	168	0	112	224	0	84	172	0	112	235	0	112	235	0	112	235	0	66	138	70	146	146	146	146	146	146	146	146	146
4344	4.1		52	105	0	56	115	0	84	172	0	112	229	0	84	176	0	112	240	0	112	240	0	112	240	0	66	141	70	149	149	149	149	149	149	149	149	149
4224	4.2		52	108	0	56	118	0	84	176	0	112	235	0	84	180	0	112	246	0	112	246	0	112	246	0	66	144	70	153	153	153	153	153	153	153	153	153
4109	4.3		52	110	0	56	120	0	84	180	0	112	240	0	84	185	0	112	252	0	112	252	0	112	252	0	66	147	70	156	156	156	156	156	156	156	156	156
4000	4.4		52	113	0	56	123	0	84	185	0	112	246	0	84	189	0	112	257	0	112	257	0	112	257	0	66	151	70	160	160	160	160	160	160	160	160	160
3896	4.5		52	116	0	56	126	0	84	189	0	112	252	0	84	193	0	112	263	0	112	263	0	112	263	0	66	154	70	163	163	163	163	163	163	163	163	163
3795	4.6		52	118	0	56	129	0	84	193	0	112	257	0	84	197	0	112	268	0	112	268	0	112	268	0	66	157	70	167	167	167	167	167	167	167	167	167
3699	4.7		52	121	0	56	132	0	84	197	0	112	263	0	84	201	0	112	274	0	112	274	0	112	274	0	66	160	70	170	170	170	170	170	170	170	170	170
3607	4.8		52	123	0	56	134	0	84	201	0	112	268	0	84	206	0	112	280	0	112	280	0	112	280	0	66	164	70	174	174	174	174	174	174	174	174	174
3518	4.9		52	126	0	56	137	0	84	206	0	112	274	0	84	210	0	112	285	0	112	285	0	112	285	0	66	167	70	177	177	177	177	177	177	177	177	177
3433	5		52	128	0	56	140	0	84	210	0	112	280	0	84	214	0	112	291	0	112	291	0	112	291	0	66	170	70	180	180	180	180	180	180	180	180	180
3351	5.1		52	131	0	56	143	0	84	214	0	112	285	0	84	218	0	112	296	0	112	296	0	112	296	0	66	174	70	184	184	184	184	184	184	184	184	184
3272	5.2		52	134	0	56	146	0	84	218	0	112	291	0	84	222	0	112	302	0	112	302	0	112	302	0	66	177	70	187	187	187	187	187	187	187	187	187
3196	5.3		52	136	0	56	148	0	84	222	0	112	296	0	84	227	0	112	307	0	112	307	0	112	307	0	66	180	70	191	191	191	191	191	191	191	191	191
3122	5.4		52	141	0	56	151	0	84	227	0	112	302	0	84	231	0	112	313	0	112	313	0	112	313	0	66	183	70	194	194	194	194	194	194	194	194	194
2982	5.5		52	144	0	56	157	0	84	235	0	112	313	0	84	235	0	112	319	0	112	319	0	112	319	0	66	187	70	198	198	198	198	198	198	198	198	198
2916	5.7		52	146	0	56	160	0	84	239	0	112	319	0	84	239	0	112	324	0	112	324	0	112	324	0	66	190	70	201	201	201	201	201	201	201	201	201
2852	5.8		52	149	0	56	162	0	84	243	0	112	324	0	84	243	0	112	330	0	112	330	0	112	330	0	66	193	70	205	205	205	205	205	205	205	205	205
2789	5.9		56	168	2	56	165	2	84	247	0	112	330	0	84	247	0	112	335	0	112	335	0	112	335	0	66	196	70	208	208	208	208	208	208	208	208	208
2729	6		56	168	2	56	168	0	84	252	0	112	335	0	84	252	0	112	341	0	112	341	0	112	341	0	66	200	70	212	212	212	212	212	212	212	212	212
2670	6.1		56	171	2	56	171	0	84	256	0	112	341	0	84	256	0	112	347	0	112	347	0	112	347	0	66	203	70	215	215	215	215	215				

TC-5.11

NOTE: L_t, L_r & w VALUES IN FEET. LISTED RADIUS IS THE MINIMUM ALLOWABLE RADIUS FOR THE CORRESPONDING E, L_t, L_r, AND w VALUES. WIDENING SHOWN IS BASED ON A WB-62 DESIGN VEHICLE.

DESIGN FACTORS FOR A DESIGN SPEED OF 70 MPH (RURAL) USING E= 8% MAX.

DESIGN VELOCITY V=70	DESIGN SOFTWARE EQUIVALENTS (NUMBER OF LANES AT LANE WIDTH)												INTERCHANGE RAMPS					
	1 @ 11'			1 @ 12'			2 @ 12'			3 @ 12'			16 FT		18 FT			
	L _t	L _r	w	L _t	L _r	w	L _t	L _r	w	L _t	L _r	w	L _t	L _r	w	L _t	L _r	w
14500	NC	0	0	0	0	0	0	0	0	0	0	0	0	0	0	0	0	0
10731	2	55	58	60	60	60	63	0	90	95	0	120	120	0	72	75	75	75
10194	2.1	55	58	0	60	66	0	90	99	0	120	132	0	72	79	75	83	83
9706	2.2	55	61	0	60	69	0	90	104	0	120	138	0	72	82	75	87	87
9260	2.3	55	64	0	60	72	0	90	108	0	120	144	0	72	86	75	90	90
8851	2.4	55	69	0	60	75	0	90	113	0	120	150	0	72	89	75	94	94
8474	2.5	55	72	0	60	78	0	90	117	0	120	156	0	72	93	75	98	98
8127	2.6	55	75	0	60	81	0	90	122	0	120	162	0	72	96	75	102	102
7805	2.7	55	77	0	60	84	0	90	126	0	120	168	0	72	100	75	105	105
7506	2.8	55	80	0	60	87	0	90	131	0	120	174	0	72	104	75	109	109
7227	2.9	55	83	0	60	90	0	90	135	0	120	180	0	72	107	75	113	113
6967	3	55	86	0	60	93	0	90	140	0	120	186	0	72	111	75	117	117
6724	3.1	55	88	0	60	96	0	90	144	0	120	192	0	72	114	75	120	120
6495	3.2	55	91	0	60	99	0	90	149	0	120	198	0	72	118	75	124	124
6281	3.3	55	94	0	60	102	0	90	153	0	120	204	0	72	121	75	128	128
6079	3.4	55	97	0	60	105	0	90	158	0	120	210	0	72	125	75	132	132
5888	3.5	55	99	0	60	108	0	90	162	0	120	216	0	72	128	75	135	135
5708	3.6	55	102	0	60	111	0	90	167	0	120	222	0	72	132	75	139	139
5537	3.7	55	105	0	60	114	0	90	171	0	120	228	0	72	136	75	143	143
5376	3.8	55	108	0	60	117	0	90	176	0	120	234	0	72	139	75	147	147
5222	3.9	55	110	0	60	120	0	90	180	0	120	240	0	72	143	75	150	150
5076	4	55	113	0	60	123	0	90	185	0	120	246	0	72	146	75	154	154
4937	4.1	55	116	0	60	126	0	90	189	0	120	252	0	72	150	75	158	158
4805	4.2	55	119	0	60	129	0	90	194	0	120	258	0	72	153	75	162	162
4679	4.3	55	121	0	60	132	0	90	198	0	120	264	0	72	157	75	165	165
4558	4.4	55	124	0	60	135	0	90	203	0	120	270	0	72	160	75	169	169
4443	4.5	55	127	0	60	138	0	90	207	0	120	276	0	72	164	75	173	173
4332	4.6	55	130	0	60	141	0	90	212	0	120	282	0	72	168	75	177	177
4226	4.7	55	132	0	60	144	0	90	216	0	120	288	0	72	171	75	180	180
4125	4.8	55	135	0	60	147	0	90	221	0	120	294	0	72	175	75	184	184
4027	4.9	55	138	0	60	150	0	90	225	0	120	300	0	72	178	75	188	188
3933	5	55	141	0	60	153	0	90	230	0	120	306	0	72	182	75	192	192
3843	5.1	55	143	0	60	156	0	90	234	0	120	312	0	72	185	75	195	195
3756	5.2	55	146	0	60	159	0	90	239	0	120	318	0	72	189	75	199	199
3673	5.3	55	149	0	60	162	0	90	243	0	120	324	0	72	192	75	203	203
3592	5.4	55	152	0	60	165	0	90	248	0	120	330	0	72	196	75	207	207
3514	5.5	55	154	0	60	168	0	90	252	0	120	336	0	72	200	75	210	210
3439	5.6	55	157	0	60	171	0	90	257	0	120	342	0	72	203	75	214	214
3366	5.7	55	160	0	60	174	0	90	261	0	120	348	0	72	207	75	218	218
3296	5.8	55	163	0	60	177	0	90	266	0	120	354	0	72	210	75	222	222
3228	5.9	55	165	0	60	180	0	90	270	0	120	360	0	72	214	75	225	225
3163	6	55	168	0	60	183	0	90	275	0	120	366	0	72	217	75	229	229
3099	6.1	55	171	0	60	186	0	90	279	0	120	372	0	72	221	75	233	233
3037	6.2	55	174	0	60	189	0	90	284	0	120	378	0	72	224	75	237	237
2977	6.3	55	176	0	60	192	0	90	288	0	120	384	0	72	228	75	240	240
2919	6.4	55	179	0	60	195	0	90	293	0	120	390	0	72	232	75	244	244
2862	6.5	60	195	2	60	198	0	90	297	0	120	396	0	72	235	75	248	248
2807	6.6	61	199	2.1	60	198	0	90	297	0	120	396	0	72	235	75	248	248
2753	6.7	61	202	2.1	60	201	0	90	302	0	120	402	0	72	239	75	252	252
2699	6.8	61	205	2.1	60	204	0	90	306	0	120	408	0	72	242	75	255	255
2645	6.9	61	208	2.1	60	207	0	90	311	0	120	414	0	72	246	75	259	259
2590	7	61	212	2.2	60	210	0	90	315	0	120	420	0	72	249	75	263	263
2535	7.1	61	215	2.2	60	213	0	90	320	0	120	426	0	72	253	75	267	267
2480	7.2	61	218	2.2	60	216	0	90	324	0	120	432	0	72	256	75	270	270
2423	7.3	61	222	2.3	60	219	0	90	329	0	120	438	0	72	260	75	274	274
2365	7.4	61	225	2.3	60	222	0	90	333	0	120	444	0	72	264	75	278	278
2305	7.5	61	228	2.3	60	225	0	90	338	0	120	450	0	72	267	75	282	282
2242	7.6	61	232	2.4	60	228	0	90	342	0	120	456	0	72	271	75	285	285
2175	7.7	61	235	2.4	60	231	0	90	347	0	120	462	0	72	274	75	289	289
2100	7.8	62	239	2.5	60	234	0	90	351	0	120	468	0	72	278	75	293	293
2010	7.9	62	243	2.6	60	237	0	90	356	0	120	474	0	72	281	75	297	297
1821	8	62	248	2.8	60	240	0	90	360	0	120	480	0	72	285	75	300	300



ROAD AND BRIDGE STANDARDS

SHEET 1 OF 1

REVISION DATE

803.42

01/13

TRANSITION CURVES - RURAL
70 MPH DESIGN SPEED

VIRGINIA DEPARTMENT OF TRANSPORTATION

SPECIFICATION
REFERENCE

DESIGN FACTORS FOR A DESIGN SPEED OF 75 MPH (RURAL) USING E = 8% MAX.																														
DESIGN VELOCITY RADIUS(FT) E(%)	WIDTH-22 FT						WIDTH-24 FT						WIDTH-48 FT						WIDTH-72 FT						INTERCHANGE RAMP					
	DESIGN SOFTWARE EQUIVALENTS (NUMBER OF LANES AT LANE WIDTH)			1 @ 11'			1 @ 12'			2 @ 12'			3 @ 12'			16 FT			18 FT											
	Lt	Lr	w	Lt	Lr	w	Lt	Lr	w	Lt	Lr	w	Lt	Lr	w	Lt	Lr	w	Lt	Lr	w	Lt	Lr	w	Lt	Lr	w			
16100	NC	0	0	0	0	0	0	0	0	0	0	0	0	0	0	0	0	0	0	0	0	0	0	0	0					
12200	2	58	58	0	64	64	0	64	64	0	95	95	0	127	127	0	75	75	0	75	75	0	75	75	0					
11805	2.1	58	61	0	64	67	0	64	67	0	95	100	0	127	134	0	75	79	0	75	79	0	75	79	0					
10920	2.2	58	64	0	64	70	0	64	70	0	95	105	0	127	140	0	75	82	0	75	82	0	75	82	0					
10483	2.3	58	67	0	64	73	0	64	73	0	95	109	0	127	146	0	75	86	0	75	86	0	75	86	0					
10001	2.4	58	70	0	64	76	0	64	76	0	95	114	0	127	153	0	75	90	0	75	90	0	75	90	0					
9559	2.5	58	73	0	64	79	0	64	79	0	95	119	0	127	159	0	75	94	0	75	94	0	75	94	0					
9152	2.6	58	76	0	64	83	0	64	83	0	95	124	0	127	166	0	75	97	0	75	97	0	75	97	0					
8777	2.7	58	79	0	64	86	0	64	86	0	95	128	0	127	172	0	75	101	0	75	101	0	75	101	0					
8507	2.8	58	82	0	64	89	0	64	89	0	95	133	0	127	178	0	75	105	0	75	105	0	75	105	0					
8181	2.9	58	84	0	64	92	0	64	92	0	95	138	0	127	185	0	75	108	0	75	108	0	75	108	0					
7950	3	58	87	0	64	95	0	64	95	0	95	143	0	127	191	0	75	112	0	75	112	0	75	112	0					
7664	3.1	58	90	0	64	98	0	64	98	0	95	147	0	127	197	0	75	116	0	75	116	0	75	116	0					
7397	3.2	58	93	0	64	102	0	64	102	0	95	152	0	127	204	0	75	120	0	75	120	0	75	120	0					
7275	3.3	58	96	0	64	105	0	64	105	0	95	157	0	127	210	0	75	123	0	75	123	0	75	123	0					
7034	3.4	58	99	0	64	108	0	64	108	0	95	162	0	127	216	0	75	127	0	75	127	0	75	127	0					
6809	3.5	58	102	0	64	111	0	64	111	0	95	166	0	127	223	0	75	131	0	75	131	0	75	131	0					
6477	3.6	58	105	0	64	114	0	64	114	0	95	171	0	127	229	0	75	134	0	75	134	0	75	134	0					
6279	3.7	58	108	0	64	117	0	64	117	0	95	176	0	127	235	0	75	138	0	75	138	0	75	138	0					
6091	3.8	58	110	0	64	120	0	64	120	0	95	180	0	127	242	0	75	142	0	75	142	0	75	142	0					
5967	3.9	58	113	0	64	124	0	64	124	0	95	185	0	127	248	0	75	146	0	75	146	0	75	146	0					
5797	4	58	116	0	64	127	0	64	127	0	95	190	0	127	254	0	75	149	0	75	149	0	75	149	0					
5635	4.1	58	119	0	64	130	0	64	130	0	95	195	0	127	261	0	75	153	0	75	153	0	75	153	0					
5579	4.2	58	122	0	64	133	0	64	133	0	95	199	0	127	267	0	75	157	0	75	157	0	75	157	0					
5430	4.3	58	125	0	64	136	0	64	136	0	95	204	0	127	273	0	75	160	0	75	160	0	75	160	0					
5287	4.4	58	128	0	64	139	0	64	139	0	95	209	0	127	280	0	75	164	0	75	164	0	75	164	0					
5151	4.5	58	131	0	64	143	0	64	143	0	95	214	0	127	286	0	75	168	0	75	168	0	75	168	0					
5020	4.6	58	134	0	64	146	0	64	146	0	95	218	0	127	292	0	75	172	0	75	172	0	75	172	0					
4881	4.7	58	137	0	64	149	0	64	149	0	95	223	0	127	299	0	75	175	0	75	175	0	75	175	0					
4762	4.8	58	139	0	64	152	0	64	152	0	95	228	0	127	305	0	75	179	0	75	179	0	75	179	0					
4647	4.9	58	142	0	64	155	0	64	155	0	95	233	0	127	312	0	75	183	0	75	183	0	75	183	0					
4537	5	58	145	0	64	158	0	64	158	0	95	237	0	127	318	0	75	187	0	75	187	0	75	187	0					
4464	5.1	58	148	0	64	162	0	64	162	0	95	242	0	127	324	0	75	190	0	75	190	0	75	190	0					
4362	5.2	58	151	0	64	165	0	64	165	0	95	247	0	127	331	0	75	194	0	75	194	0	75	194	0					
4263	5.3	58	154	0	64	168	0	64	168	0	95	252	0	127	337	0	75	198	0	75	198	0	75	198	0					
4169	5.4	58	157	0	64	171	0	64	171	0	95	256	0	127	343	0	75	201	0	75	201	0	75	201	0					
4023	5.5	58	160	0	64	174	0	64	174	0	95	261	0	127	350	0	75	205	0	75	205	0	75	205	0					
3980	5.6	58	163	0	64	177	0	64	177	0	95	266	0	127	356	0	75	209	0	75	209	0	75	209	0					
3938	5.7	58	165	0	64	180	0	64	180	0	95	270	0	127	362	0	75	213	0	75	213	0	75	213	0					
3804	5.8	58	168	0	64	184	0	64	184	0	95	275	0	127	369	0	75	216	0	75	216	0	75	216	0					
3725	5.9	58	171	0	64	187	0	64	187	0	95	280	0	127	375	0	75	220	0	75	220	0	75	220	0					
3648	6	58	174	0	64	190	0	64	190	0	95	285	0	127	381	0	75	224	0	75	224	0	75	224	0					
3574	6.1	58	177	0	64	193	0	64	193	0	95	289	0	127	388	0	75	227	0	75	227	0	75	227	0					
3533	6.2	58	180	0	64	196	0	64	196	0	95	294	0	127	394	0	75	231	0	75	231	0	75	231	0					
3462	6.3	58	183	0	64	199	0	64	199	0	95	299	0	127	400	0	75	235	0	75	235	0	75	235	0					
3394	6.4	58	186	0	64	203	0	64	203	0	95	304	0	127	407	0	75	239	0	75	239	0	75	239	0					
3328	6.5	58	189	0	64	206	0	64	206	0	95	308	0	127	413	0	75	242	0	75	242	0	75	242	0					
3268	6.6	64	209	2	64	209	0	64	209	0	95	313	0	127	419	0	75	246	0	75	246	0	75	246	0					
3209	6.7	64	212	2	64	212	0	64	212	0	95	318	0	127	426	0	75	250	0	75	250	0	75	250	0					
3149	6.8	64	215	2	64	215	0	64	215	0	95	323	0	127	432	0	75	254	0	75	254	0	75	254	0					
3088	6.9	64	218	2	64	218	0	64	218	0	95	327	0	127	438	0	75	257	0	75	257	0	75	257	0					
3029	7	64	222	2.1	64	222	0	64	222	0	95	332	0	127	445	0	75	261	0	75	261	0	75	261	0					
3010	7.1	64	226	2.1	64	225	0	64	225	0	95	337	0	127	451	0	75	265	0	75	265	0	75	265	0					
2942	7.2	64	229	2.1	64	228	0	64	228	0	95	342	0	127	458	0	75	268	0	75	268	0	75	268	0					
2856	7.3	64	232	2.1	64	231	0	64	231	0	95	346	0	127	464	0	75	272	0	75	272	0	75	272	0					
2796	7.4	64	236	2.2	64	234	0	64	234	0	95	351	0	127	470	0	75	276	0	75	276	0	75	276	0					
2781	7.5	64	239	2.2	64	237	0	64	237	0	95	356	0	127	477	0	75	280	0	75	280	0	75	280	0					
2704	7.6	64	242	2.2	64	240	0	64	240	0	95	360	0	127	483	0	75	283	0	75	283	0	75	283	0					
2615	7.7	64	247	2.3	64	244	0	64	244	0	95	365	0	127	489	0	75	287	0	75	287	0	75	287	0					
2520	7.8	64	250	2.3	64	247	0	64	247	0	95	370	0	127	496	0	75	291	0	75	291	0	75	291	0					
2480	7.9	64	253	2.3	64	250	0	64	250	0	95	375	0	127	502	0	75	294	0	75	294	0	75	294	0					
2215	8	65	258	2.5	64	253	0	64	253	0	95	379	0	127	508	0	75	298	0	75	298	0	75	298	0					

TC-5.11

NOTE: Lt, Lr & w

TC-5.11

NOTE: Lt, Lr & w VALUES IN FEET. LISTED RADIUS IS THE MINIMUM ALLOWABLE RADIUS FOR THE CORRESPONDING E, Lt, Lr, AND w VALUES. WIDENING SHOWN IS BASED ON A WB-62 DESIGN VEHICLE.

DESIGN FACTORS FOR A DESIGN SPEED OF 80 MPH (RURAL) USING E= 8% MAX.

DESIGN VELOCITY +80	DESIGN SOFTWARE EQUIVALENTS (NUMBER OF LANES AT LANE WIDTH)												INTERCHANGE RAMPS			
	WIDTH=22 FT			WIDTH=24 FT			WIDTH=48 FT			WIDTH=72 FT			16 FT		18 FT	
	Lt	Lr	w	Lt	Lr	w	Lt	Lr	w	Lt	Lr	w	Lt	Lr	Lt	Lr
17800	NC	0	0	0	0	0	0	0	0	0	0	0	0	0	0	0
13704	2	63	63	0	69	69	0	103	103	0	138	138	0	83	83	86
12749	2.1	63	66	0	69	72	0	103	108	0	138	145	0	83	87	90
12340	2.2	63	70	0	69	76	0	103	114	0	138	152	0	83	91	95
11845	2.3	63	73	0	69	79	0	103	119	0	138	159	0	83	95	99
11401	2.4	63	76	0	69	83	0	103	124	0	138	166	0	83	99	103
10706	2.5	63	79	0	69	86	0	103	129	0	138	173	0	83	103	108
10251	2.6	63	82	0	69	90	0	103	134	0	138	180	0	83	107	112
9831	2.7	63	85	0	69	93	0	103	139	0	138	187	0	83	111	116
9528	2.8	63	88	0	69	96	0	103	144	0	138	193	0	83	115	120
9163	2.9	63	92	0	69	100	0	103	150	0	138	200	0	83	119	125
8904	3	63	95	0	69	103	0	103	155	0	138	207	0	83	124	129
8584	3.1	63	98	0	69	107	0	103	160	0	138	214	0	83	128	133
8358	3.2	63	101	0	69	110	0	103	165	0	138	221	0	83	132	138
8148	3.3	63	104	0	69	114	0	103	170	0	138	228	0	83	136	142
7881	3.4	63	107	0	69	117	0	103	175	0	138	235	0	83	140	146
7490	3.5	63	110	0	69	120	0	103	180	0	138	242	0	83	144	150
7319	3.6	63	114	0	69	124	0	103	186	0	138	249	0	83	148	155
7096	3.7	63	117	0	69	127	0	103	191	0	138	255	0	83	152	159
6883	3.8	63	120	0	69	131	0	103	196	0	138	262	0	83	156	163
6743	3.9	63	123	0	69	134	0	103	201	0	138	269	0	83	160	168
6550	4	63	126	0	69	138	0	103	206	0	138	276	0	83	164	172
6367	4.1	63	129	0	69	141	0	103	211	0	138	283	0	83	169	176
6193	4.2	63	132	0	69	144	0	103	216	0	138	290	0	83	173	180
6038	4.3	63	136	0	69	148	0	103	222	0	138	297	0	83	177	185
5868	4.4	63	139	0	69	151	0	103	227	0	138	304	0	83	181	189
5820	4.5	63	142	0	69	155	0	103	232	0	138	311	0	83	185	193
5656	4.6	63	145	0	69	158	0	103	237	0	138	318	0	83	189	198
5499	4.7	63	148	0	69	162	0	103	242	0	138	324	0	83	193	202
5405	4.8	63	151	0	69	165	0	103	247	0	138	331	0	83	197	206
5274	4.9	63	154	0	69	168	0	103	252	0	138	338	0	83	202	210
5150	5	63	158	0	69	172	0	103	258	0	138	345	0	83	206	215
5067	5.1	63	161	0	69	175	0	103	263	0	138	352	0	83	210	219
4951	5.2	63	164	0	69	179	0	103	268	0	138	359	0	83	214	223
4775	5.3	63	167	0	69	182	0	103	273	0	138	366	0	83	218	228
4669	5.4	63	170	0	69	186	0	103	278	0	138	373	0	83	222	232
4586	5.5	63	173	0	69	189	0	103	283	0	138	380	0	83	226	236
4497	5.6	63	176	0	69	192	0	103	288	0	138	386	0	83	230	240
4410	5.7	63	180	0	69	196	0	103	294	0	138	393	0	83	234	245
4337	5.8	63	183	0	69	199	0	103	299	0	138	400	0	83	238	249
4267	5.9	63	186	0	69	203	0	103	304	0	138	407	0	83	243	253
4227	6	63	189	0	69	206	0	103	309	0	138	414	0	83	247	258
4146	6.1	63	192	0	69	210	0	103	314	0	138	421	0	83	251	262
4047	6.2	63	195	0	69	213	0	103	319	0	138	428	0	83	255	266
3966	6.3	63	198	0	69	216	0	103	324	0	138	435	0	83	259	270
3877	6.4	63	202	0	69	220	0	103	330	0	138	442	0	83	263	275
3860	6.5	63	205	0	69	223	0	103	335	0	138	448	0	83	267	279
3790	6.6	63	208	0	69	227	0	103	340	0	138	455	0	83	271	283
3723	6.7	63	211	0	69	230	0	103	345	0	138	462	0	83	275	288
3652	6.8	63	214	0	69	234	0	103	350	0	138	469	0	83	279	292
3582	6.9	63	217	0	69	237	0	103	355	0	138	476	0	83	284	296
3513	7	69	240	2	69	240	0	103	360	0	138	483	0	83	288	300
3467	7.1	69	244	2	69	244	0	103	366	0	138	490	0	83	292	305
3425	7.2	69	247	2	69	247	0	103	371	0	138	497	0	83	296	309
3354	7.3	69	251	2	69	251	0	103	376	0	138	504	0	83	300	313
3324	7.4	69	254	2	69	254	0	103	381	0	138	510	0	83	304	318
3218	7.5	69	259	2.1	69	258	0	103	386	0	138	517	0	83	308	322
3159	7.6	69	262	2.1	69	261	0	103	391	0	138	524	0	83	312	326
3115	7.7	69	266	2.1	69	264	0	103	396	0	138	531	0	83	316	330
3029	7.8	69	269	2.1	69	268	0	103	402	0	138	538	0	83	320	335
2895	7.9	70	274	2.2	69	271	0	103	407	0	138	545	0	83	325	339
2675	8	70	278	2.3	69	275	0	103	412	0	138	552	0	83	329	343



ROAD AND BRIDGE STANDARDS

SHEET 1 OF 1

REVISION DATE

803.44

01/13

TRANSITION CURVES - RURAL
80 MPH DESIGN SPEED

VIRGINIA DEPARTMENT OF TRANSPORTATION

SPECIFICATION
REFERENCE